

4310114

Model 431

Shoppertron

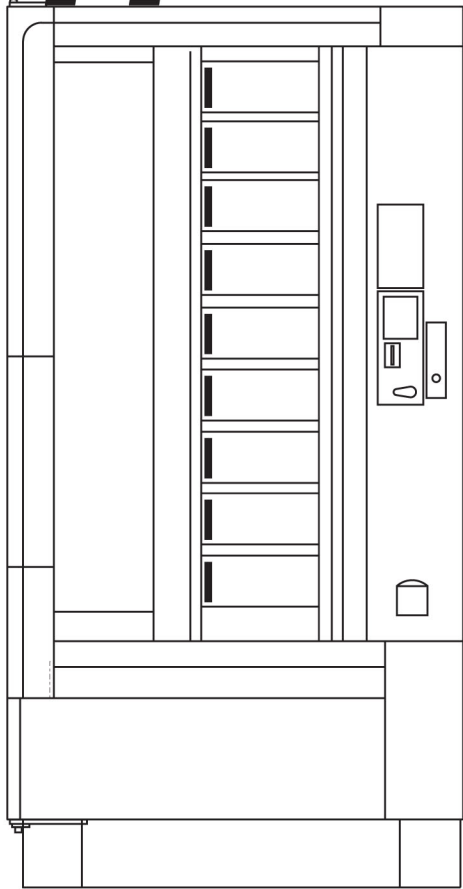

Operator's Guide

This machine has been engineered to our own rigid safety and performance standards. It has been designed to comply with sanitation and health guidelines recommended by the Automatic Merchandising Health-Industry Council (AMHIC) and it conforms with all other NAMA safety recommendations.

This machine has been manufactured in accordance with the safety standards of both Underwriter's Laboratories and the Canadian Standards Association. To maintain this degree of safety and to continue to achieve the level of performance built into this machine, it is important that installation and maintenance be performed so as to not alter the original construction or wiring and that replacement parts are as specified in the **Parts Manual**. Your investment in this equipment will be protected by using this **Operator's Guide** and the **Parts Manual** in your operation, service and maintenance work. By following prescribed procedures, machine performance and safety will be preserved.

Table of Contents

Section I. Preparing the Merchandiser for Vending	1
Initial Set-Up.....	3
Section II. Programming Operations	9
Control Panel Switch Functions Explained.....	11
Programming Flow Charts.....	12
Alphabetical Index of Programming Functions.....	15
Gain Access to the Supervisor Mode	17
Enter a New Supervisor Code	17
Enter a New Data Recall Code	18
Lock or Unlock Mode or Payout Keys	19
Set Printer or DEX Options.....	19
Lock or Unlock Data Clearing Access	20
Select Printer Baud Rate	20
Select Display Language.....	20
Select Coin Mechanism and Options	21
Select Bill Validator and Options	21
Initial Setup Of Non-Standard Bill Validator	22
Select Card Reader and Options	23
Select Monetary Options	24
Set Up Winner Mode	26
Set Shop Zones.....	27
Set Number of Compartments	28
Set Zone Preference	29
Set View Delay Time	29
Set Door Delay Time	29
Set Align/No Align Options	30
Display Prices.....	30
Change Temperature	31
Show the Temperature in Standby Mode	31
Set Defrost Options	32
Turn Tamper Check On or Off	33
Check for Tampering	33
View Software Version	34
Set the Time	34
Set Day of the Week, Month, Date, and Year	34
Set Daylight Savings Option	35
Set Time-Of-Day Inhibited Vending.....	35
Set Time-Of-Day Free Vending.....	35
Set Time-Of-Day Discount Vending	35
Time Interval Editing	36
Select an Out-Of-Service Message	38
Select a Freevend Message.....	38
Edit Custom Messages	39

Shoppertron™ Operator's Guide

View Machine Temperature	41
Payout Coins	41
Set Prices	42
View Nonresettable Sales and Vend Data	42
View Total Paid Sales	43
View Total Paid Sales by Zone.....	43
View Total Paid Sales by Level	43
View Discount Sales by Time Interval	44
View Total Paid Vends	44
View Card Reader Paid Sales	44
View Total Unpaid Sales	45
View Total Unpaid Sales by Zone	45
View Total Unpaid Sales by Level.....	45
View Free Vends	46
View Winners.....	46
View Freevend Sales by Time Interval.....	46
View Time Data	47
View Machine ID Number.....	48
Clear All Resettable Data	48
Clear Paid Sales Data Only	49
Test Vend Selections and Verify Credit Added	49
Test the Display.....	49
Download Data To a PDCD	50
View Diagnostic Messages.....	50
Set Freevend Options	53
Section III. Routine Service and Sanitation.....	54
Section IV. Adjustment, Removal, and Replacement Procedures	58

Shoppertron™ Operator's Guide

Section I. Preparing the Merchandiser for Vending

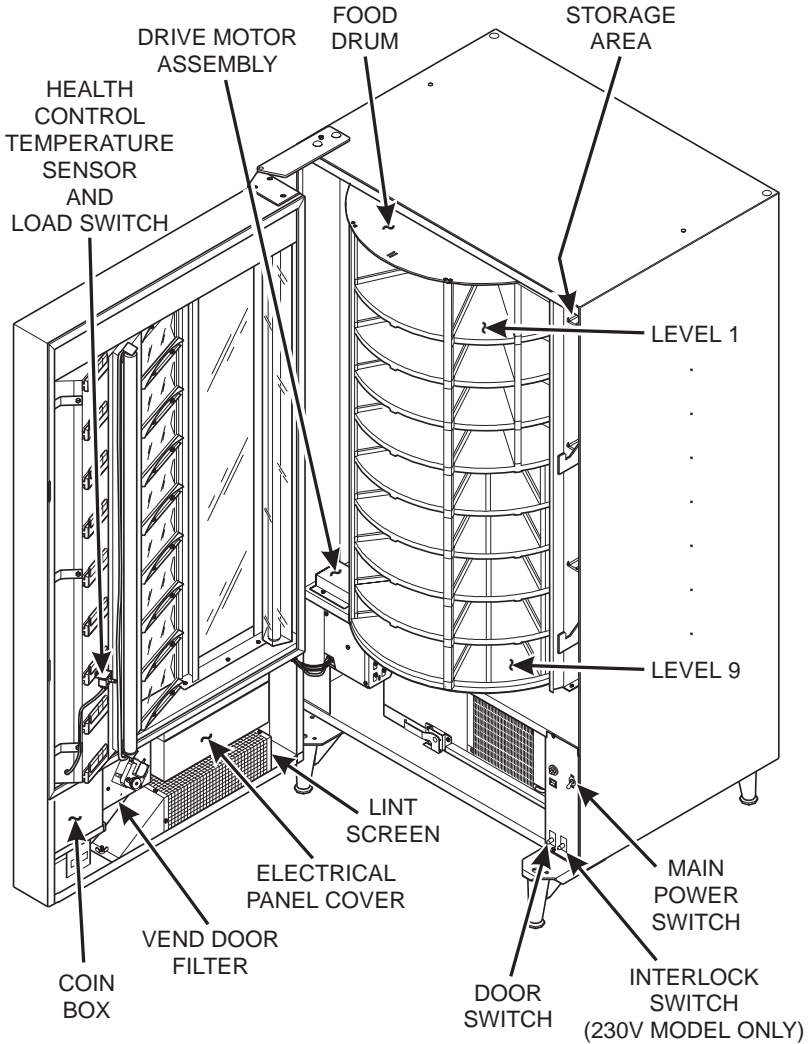

Shoppertron™ Operator's Guide

Health Control

The Shoppertron merchandiser is equipped with an electronic health control (required by most state and local health authorities). The health control prevents vending merchandise that could be spoiled.

The merchandiser will automatically go into an out-of-service mode (*H.C.E.R.*) and food will not be vended if any of the following conditions occur:

- The temperature of the refrigerated cabinet does not fall to 41° F (5° C) within 30 minutes after the door of the refrigerated cabinet is closed or after a defrost.
- The temperature of the cabinet rises above 41° F (5° C) for more than 15 minutes without the door of the refrigerated cabinet having been open.
- For testing purposes, the temperature of the cabinet rises above 41° F (5° C) for at least one second with the refrigerated door open.

When health control is triggered, the display will read *TEMPORARY OUT OF SERVICE*. When the monetary door is opened, the message shows *H.C.E.R.*, and the date, time, and maximum cabinet temperature reached are displayed. To reset the health control, the refrigerated cabinet door must be opened and closed again.

The out-of-service condition usually occurs at initial setup. Therefore, National Vendors recommends the merchandiser be operated with the refrigerated compartment left empty until the temperature reaches a level low enough to satisfy the health control.

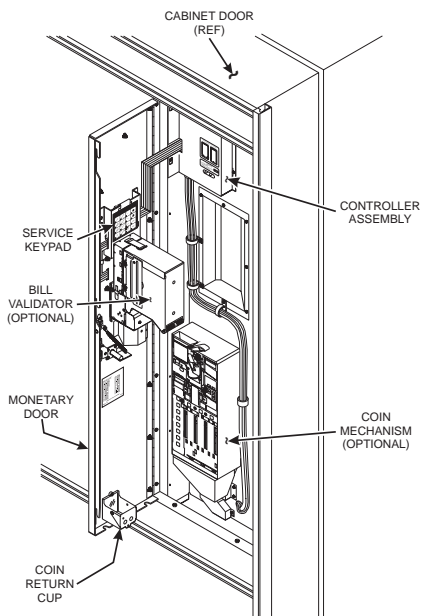

Initial Set-Up

Unpack And Inspect

1. Carefully remove the merchandiser from its shipping carton and place it on a level surface.
2. Inspect the outside of the merchandiser for dents, scratches, or any damage resulting from improper handling.
3. Open the monetary compartment. If the merchandiser has the optional door lock, the key will be in the coin return receptacle.
4. Inspect the inside of the cabinet. Observe the location and position of the packing material should you need to reuse it. Carefully remove all packing material.

IMPORTANT

If you saw any damage when you unpacked the merchandiser, file a claim immediately with the carrier.

5. Instructions for installing the optional Base Plate are included with the Base Plate Assembly when shipped.
6. Inspect the merchandiser's electrical connectors and components.

Utility Requirements

This merchandiser is supplied with a service cord for the country of use and is terminated in a grounding type plug. The wall receptacle used for this merchandiser must be properly polarized, grounded, and of the correct voltage. Operating the merchandiser from a source of low voltage will **VOID YOUR WARRANTY**. Each merchandiser should have its own electrical circuit and that circuit should be protected with a circuit breaker or fuse conforming to local regulations.

Voltage Check - Place the leads of a voltmeter across the LINE (LIVE) and NEUTRAL terminals of the wall receptacle. The voltmeter should indicate 110-130 volts ac for 120 volt, 60 Hz locations, or 220-240 volts ac for 230 volt, 50 Hz locations.

Polarity Check - Place the leads of a voltmeter across the LINE (LIVE) and GROUND terminals of the wall receptacle. The voltmeter should indicate 110-130 volts ac for 120 volt, 60 Hz locations, or 220-240 volts ac for 230 volt, 50 Hz locations.

Noise Potential Check - Place the leads of a voltmeter across the NEUTRAL and GROUND terminals of the wall receptacle. The voltmeter should indicate 0 volts ac. A measurement greater than 1.5-2.0 volts ac could result in problems for the merchandiser's electronic circuitry caused by electrical noise.

Any deviation from these requirements could result in unreliable performance from your merchandiser.

Shoppertron™ Operator's Guide

Installation

NOTICE

This merchandiser is intended for INDOOR use only.

CAUTION

Make sure the merchandiser is properly leveled on a flat, solid, stable floor or base foundation. **IF THIS IS NOT DONE,**

PERSONAL INJURY AND/OR DAMAGE TO EQUIPMENT
MAY RESULT!

1. Move the merchandiser to the desired location. It may be necessary to remove the door in order to move the merchandiser through a narrow doorway. Be careful when disconnecting the wiring harness. To reconnect wiring, refer to the figure below
2. Position the merchandiser at least 6 inches (15 cm) from any wall.

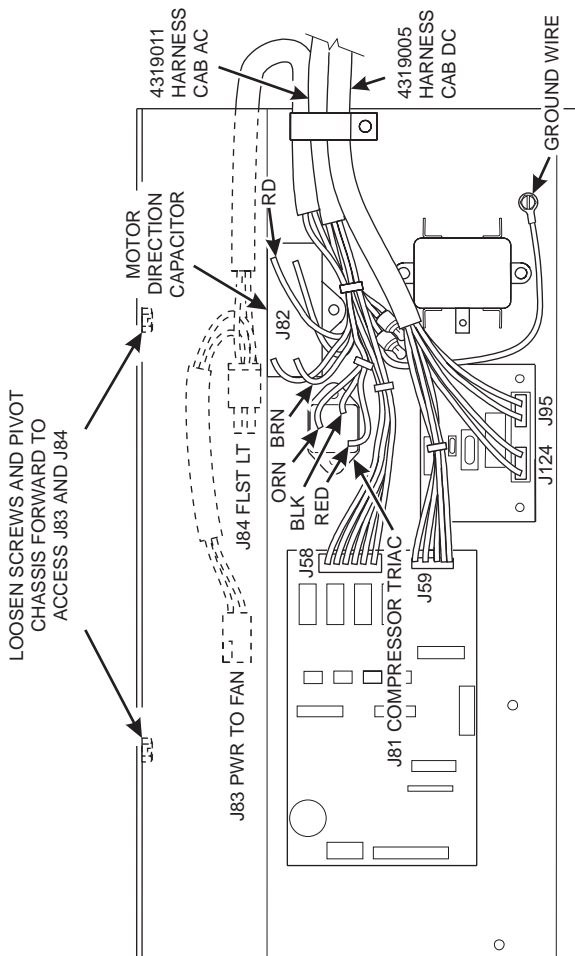

Shoppertron™ Operator's Guide

- Using a spirit level, adjust the legs with an open end or adjustable wrench until the merchandiser is level front to back and side to side.
- For "bank style" installations of multiple merchandisers:
 - Position the first machine in the location, or at the highest spot if the floor is not level. Extend the leg levelers only as required to level the machine.
 - Position and level the remaining machines.
- Make sure the main power switch is set to OFF.

IMPORTANT

Do not apply power to the merchandiser until you have done the power source checks outlined above. Possible equipment damage could result from improper supply voltage.

- Plug in the merchandiser.
- Turn the main power switch ON and close the cabinet door. The display lamp will light, and the vent fan motor will run.

Install the Coin Mechanism

WARNING

Make sure the main power switch is turned OFF before you work on the merchandiser. Failure to do so could result in death or injury.

- Turn OFF the main power switch. Refer to the instructions provided with the coin mechanism and remove the coin validator assembly.
- Set any option switches as desired. On a Mars TRC 6000, switch 2 should be set to high quarter sens. (off).
- Loosen the coin mechanism mounting screws on the merchandiser so they stand off about 1/8" (0.3 cm).
- Position the coin mechanism so the three keyed holes fit over the mounting screws. Pull down on the coin mechanism to seat the screws in the keyways.
- Tighten the mounting screws and reinstall the coin validator assembly.

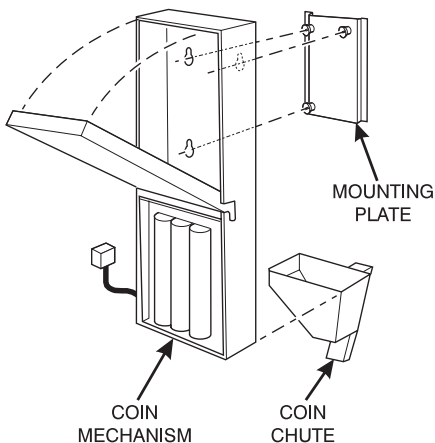

Shoppertron™ Operator's Guide

6. The following figure shows a coin mechanism, bill validator, and card reader connected to one another via an MDB. Some monetary configurations may not include all of these devices. Connect your coin MDB mechanism as shown:

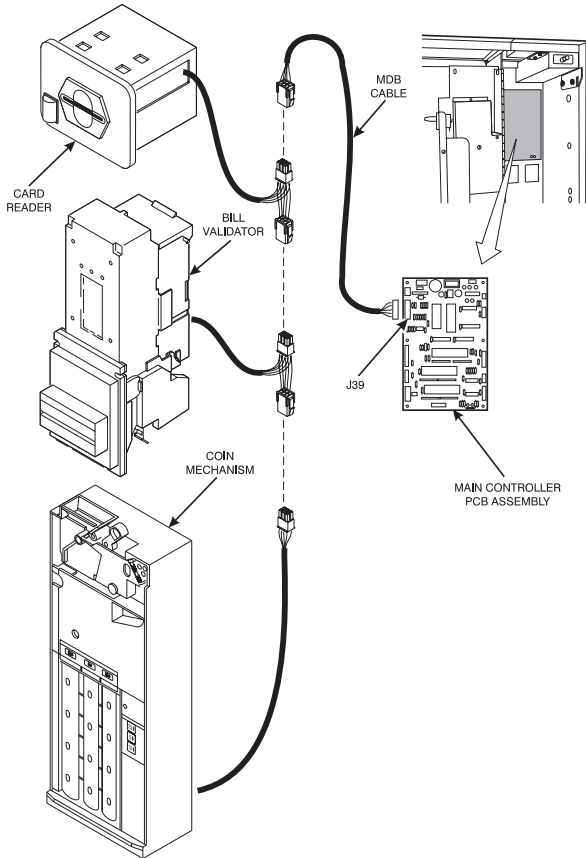

7. Turn ON the main power switch. Select the proper coin mechanism as in

"Select Coin Mechanism and Options" on page 21. Press until

the standby message is displayed, then press



8. Insert enough coins through the coin slot into the coin tubes to more than cover the empty sensor. Insert coins one at a time and ensure they lay flat in the tubes. The amount of coins you insert is internally recorded.
9. Manually finish filling all the tubes with coins.
10. Visually check the coin tubes to make sure coins are not shingled.
11. Turn OFF the main power switch.

Shoppertron™ Operator's Guide

Install the Door Lock

There are two optional door locks available from National Vendors:

FLEX-ACE (P/N 9992000)

Corresponding key (P/N 9994000)

VAN LOCK (P/N 3112163)

Corresponding key (P/N 3112164)

Lock and key kit (P/N 3122165)

Install the door lock as follows:

1. Remove the lock spring.
2. Depress the lock pin and push the lock cylinder in the lever until the pin snaps into place.
3. Test the lock mechanism with the key.

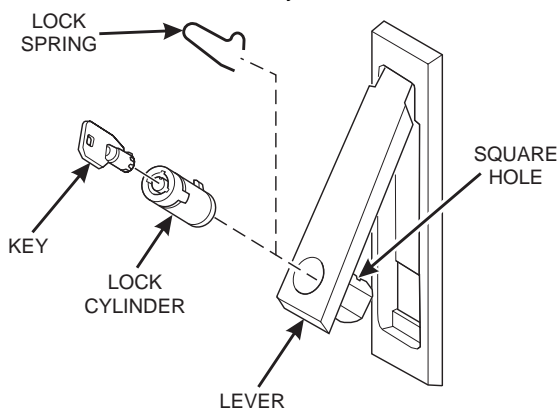

Install the Money Box Lock

Install the optional money box lock as follows:

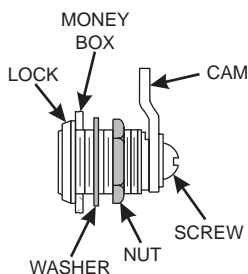

1. Remove the money box from the merchandiser.
2. Remove the screw, cam, nut, and washer from the lock assembly.
3. Insert the lock into the opening in the money box. Secure with the washer and nut.
4. Install the cam and secure with the screw.
5. Place the money box back in the merchandiser and test the lock with the key (provided).

Shoppertron™ Operator's Guide

Load the Merchandiser

There are two loading modes: The first is Full Shop, in which the entire drum is loaded. The second is Limited Shop, where only one or two zones of the drum are loaded. Limited Shop is usually used in smaller locations where all food in the merchandiser may not be vended before the freshness dates expire. To set the loading mode, refer to "**Set Shop Zones**" on page 27. The general loading procedure is as follows:

1. Adjust the product dividers, if necessary. See "**Adjusting the Product Dividers**" on page 58.
2. Set new prices, if desired. See "**Set Prices**" on page 42.
3. Set discount prices, if desired. See "**Set Time-Of-Day Discount Vending**" on page 35.

IMPORTANT

The load switch overrides the Limited Shop mode, which allows unused zone(s) of the drum to be loaded.

NOTICE

If the drum is loaded with food which is too large for the compartments, the drum will not rotate properly.

4. Push the loading switch plunger until the drum rotates to the position where you want to load food items, then release the plunger.

NOTE

You can pull out the loading switch plunger and the drum will rotate continuously until you push the plunger in to the mid position.

5. Load the food drum, then repeat step 4 until the drum is loaded.
6. Tell the machine that it is full. Do this by performing the "**Check for Tampering**" on page 33.
7. Close the refrigeration door.

Shoppertron™ Operator's Guide

Section II. Programming Operations

Some setup, test, and maintenance operations are computer controlled. The control panel switches and the selection panel switches regulate these operations.

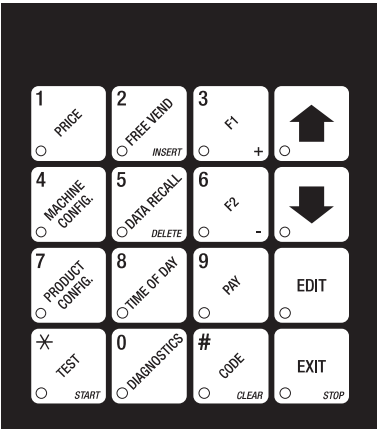

Control Panel

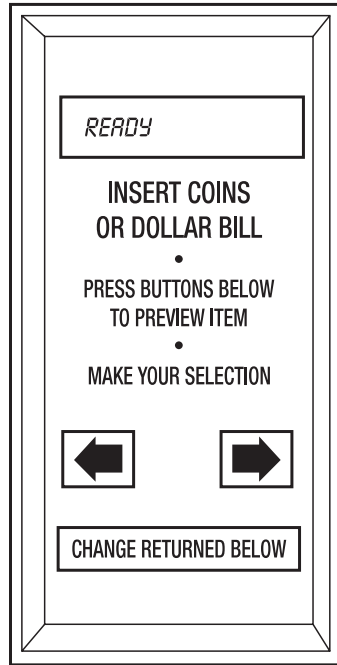

Selection Panel

The Displays

The 10-character display performs two functions, and is referred to in this book as "the display":

1. It shows the customer's selection and how much credit is in the machine, as well as the ready, service, and time of day messages.
2. It provides information and feedback to the service person during maintenance.

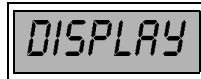

Shoppertron™ Operator's Guide

The Function Keys

The keys on the control panel can be used for up to three things:

THE NUMBER

YOU MIGHT BE ASKED TO ENTER A NUMERICAL VALUE. PRESSING THIS KEY WILL ENTER A "5".



THE PRIMARY PURPOSE

THIS IS THE MAIN JOB OF THE KEY. FROM THE STANDBY MESSAGE, IT WILL ALLOW YOU TO ENTER A PROGRAMMING MODE. IN THIS EXAMPLE, YOU CAN VIEW STORED SALES DATA.

THE SECONDARY PURPOSE

THIS IS THE KEY'S "SECOND JOB". FOR EXAMPLE, THIS KEY CAN BE USED TO DELETE A CHARACTER WHEN YOU ARE EDITING CUSTOM MESSAGES.

Other Keys

The MOVEMENT keys on the control panel let you move inside a mode, and back and forth between modes. To see how these keys let you move around, study the flow diagram on the next page.



The up and down arrow keys are your "legs", which let you move up and down the list of tasks. These keys are what let you continue from one step to the next in programming procedures.



In most instances, this key on the Selection Panel does the same job as the down arrow key.



This is your "activate" or "choose" key. It "opens a door" to additional information and lets you begin a programming task once you are inside of a mode. Sometimes, it is used as a toggle switch to show you your choices during a programming task.



In most instances, this key on the Selection Panel does the same job as the EDIT key.



This is your "end" key. Pressing it one or more times will move you back to the start of the mode, or all the way back to the standby message.

One Last Thing:

CONTINUE at the end of a function means to press  until you return to the standby message.

Shoppertron™ Operator's Guide

Control Panel Switch Functions Explained

Each of the control panel switches has one or more jobs to do. This list will give you a short overview of those jobs.



Press this button to put your machine into the Price Setting mode. You can see maximum and minimum machine prices, and change prices for entire machine, entire tray, or individual selection.



Press this button to select the Free Vend modes.



Press this button to view machine temperature, software version number, status of unsold product in tamper check or prefer max.



Press this button to:

- Select display language
- Select monetary options
- Select coin mechanism bill validator, card reader, and options
- Set winner feature



Press this button to view total sales and vends by whole machine, zone, or level. Clear resettable data.



Press this button to:

- Download data into your portable data collection device (PDCD),
- OR**

- Set printer baud rate, depending upon which device you are using

Press this button to:

- Set number of products per tray
- Set door and view delays
- Set shop zones
- Set drum alignment
- Set zone preference
- Set up tamper protection



Press this button to:

- Set time of day and date
- Set up time of day intervals for inhibit, freevend, and discount vending
- Select display messages
- Edit messages



Press this button to pay one or more coins from the coin mechanism.



Press this button to see any fault or condition that may place the machine out of service



Press this button to:

- Perform TEST VENDS
- Test displays
- Test various machine functions



Press this button to:

- Enter and change the SUPERVISOR code
- Lock and unlock access to functions

Shoppertron™ Operator's Guide

Programming Flow Charts

After you become familiar with the programming functions, you will be able to perform them without using the detailed, step-by-step tables. The following group of flow charts will give you a quick reference to the functions each key performs. If you need additional information, just refer to the page shown in the chart.

Machine Configuration Functions

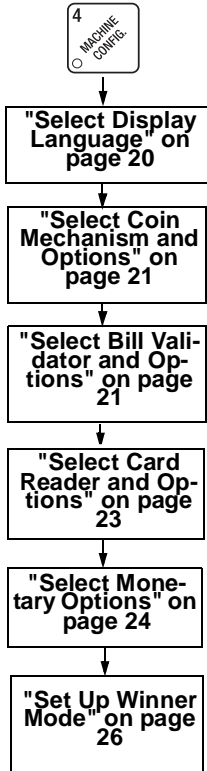

Pricing

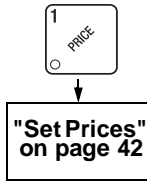

View Diagnostics

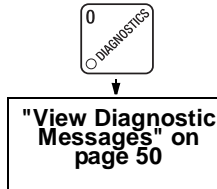

Product Configuration Functions

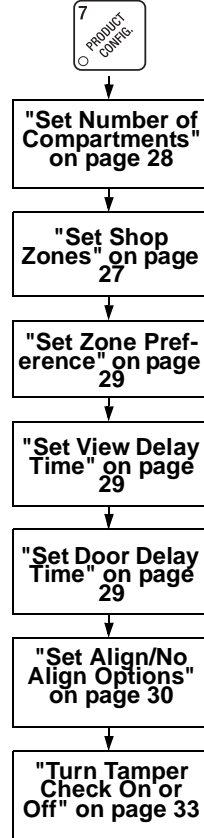

Tests

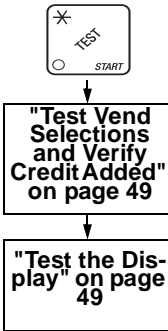

Free Vend

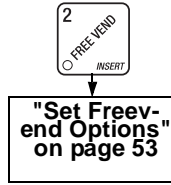

Payout Coins

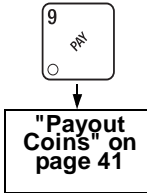

Misc.

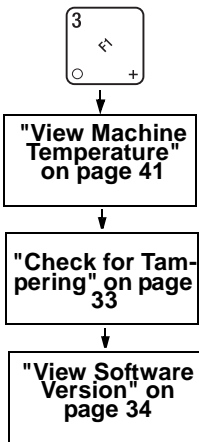

Supervisor Functions

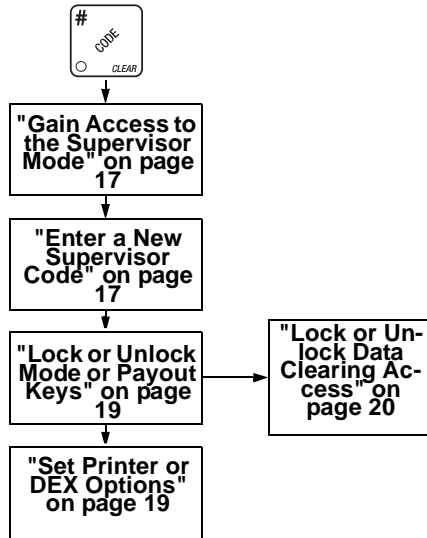

DEX/Printer

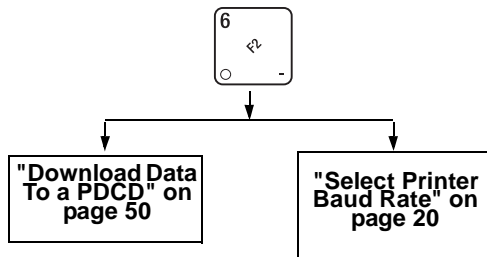

Shoppertron™ Operator's Guide

Time of Day

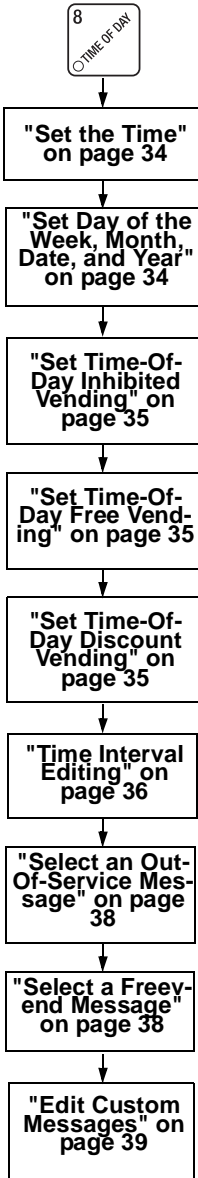

Data

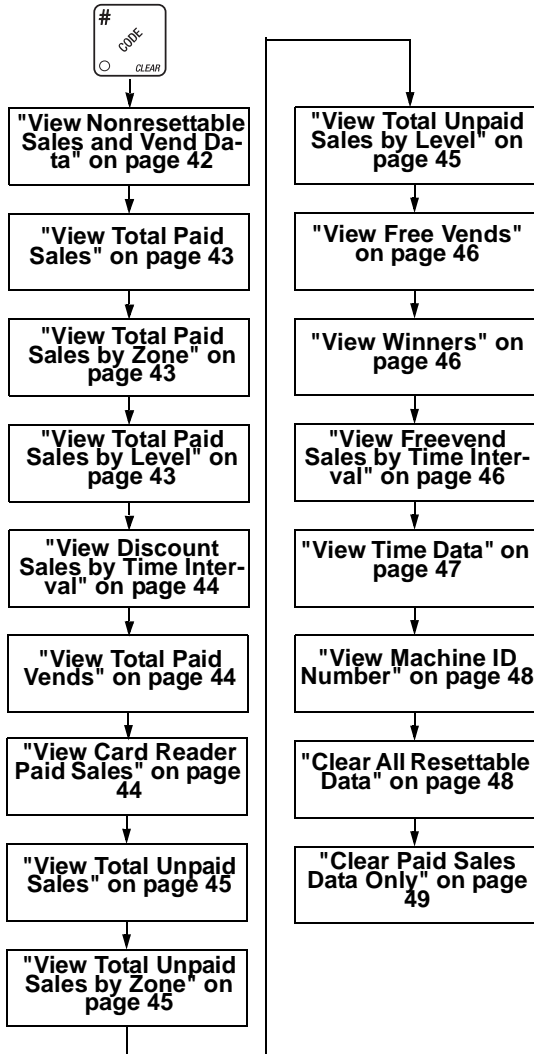

Alphabetical Index of Programming Functions

Change Temperature	31
Check for Tampering	33
Clear All Resettable Data	48
Clear Paid Sales Data Only	49
Display Prices	30
Download Data To a PDCD	50
Edit Custom Messages	39
Enter a New Data Recall Code	18
Enter a New Supervisor Code	17
Gain Access to the Supervisor Mode	17
Initial Setup Of Non-Standard Bill Validator	22
Lock or Unlock Data Clearing Access	20
Lock or Unlock Mode or Payout Keys	19
Payout Coins	41
Select a Freevend Message	38
Select an Out-Of-Service Message	38
Select Bill Validator and Options	21
Select Card Reader and Options	23
Select Coin Mechanism and Options	21
Select Display Language	20
Select Monetary Options	24
Select Printer Baud Rate	20
Set Align/No Align Options	30
Set Day of the Week, Month, Date, and Year	34
Set Daylight Savings Option	35
Set Defrost Options	32
Set Door Delay Time	29
Set Freevend Options	53
Set Number of Compartments	28
Set Prices	42
Set Printer or DEX Options	19
Set Shop Zones	27
Set the Time	34
Set Time-Of-Day Discount Vending	35
Set Time-Of-Day Free Vending	35
Set Time-Of-Day Inhibited Vending	35
Set Up Winner Mode	26
Set View Delay Time	29
Set Zone Preference	29
Show the Temperature in Standby Mode	31

Shoppertron™ Operator's Guide

Test the Display	49
Test Vend Selections and Verify Credit Added	49
Time Interval Editing	36
Turn Tamper Check On or Off	33
View Card Reader Paid Sales	44
View Diagnostic Messages.....	50
View Discount Sales by Time Interval	44
View Free Vends	46
View Freevend Sales by Time Interval	46
View Machine ID Number	48
View Machine Temperature.....	41
View Nonresettable Sales and Vend Data	42
View Software Version	34
View Time Data	47
View Total Paid Sales by Level	43
View Total Paid Sales by Zone.....	43
View Total Paid Sales.....	43
View Total Paid Vends	44
View Total Unpaid Sales by Level	45
View Total Unpaid Sales by Zone	45
View Total Unpaid Sales	45
View Winners.....	46

Shoppertron™ Operator's Guide



GAIN ACCESS TO THE SUPERVISOR MODE

1. Press . The display shows: *ENTER CODE*. You must enter the four-digit supervisor code within 6 seconds to gain access.

NOTE



A new machine has a factory-set supervisor code of 0000.

When you have entered the right code, you will hear two beeps and see *UNLOCKED* in the display. After a few moments, the standby message returns.



ENTER A NEW SUPERVISOR CODE

1. Follow the steps in **GAIN ACCESS TO THE SUPERVISOR MODE**.

2. Press , then  until the display shows *SUPER XXXX*. The X's represent the current supervisor code. Use the number keys to enter a new code.

IMPORTANT!

If you enter a new code, be sure to keep a written record of it. There is no other way to access the SUPERVISOR mode.

3. CONTINUE.

SPECIAL NOTE

If the display shows *FREE 0000*:



This is a freevend code that is not applicable to this machine. **DO NOT** enter a number to replace the



ENTER A NEW DATA RECALL CODE (Supervisor Mode Only)

If the proper non-zero code is entered, sales and non-resettable sales data can be viewed without opening the machine's door.

1. Follow the steps in "**Gain Access to the Supervisor Mode**" on page 17.

2. Press  , then  until the display shows *NR XXXX*. The X's

represent the currently entered code. Use the number keys to enter a new code, if desired. Do not use any zeros in the code, as there is no way to enter a zero with the machine door closed.

NOTE

A code of 0000 disables this feature and is also the default.

Usage:

With the machine in ready mode, enter the 4-digit code by sliding the door of the level that corresponds to the number you wish to enter. For example, to enter 1122, slide a door on the top level twice, then slide a door on the second level twice.

NOTE

The last door you slide must be off-line (in a non-vendable position) for the sales total to display.

When the correct code is entered, the non-resettable sales total is displayed. The machine total will show in the main display, and the dollar total for each level will show in the price displays. To see the exact total for a level, slide a door on that level to the right. The dollar and cents total will show on the main display.

This display will remain active for 9 seconds, or until another key is pressed.

3. CONTINUE.

Shoppertron™ Operator's Guide



LOCK OR UNLOCK MODE OR PAYOUT KEYS

1. Follow the steps in "**Gain Access to the Supervisor Mode**" on page 17.

2. Press  , then  until the display shows either:

#. LOCKED or **#. UNLOCKED**.

The pound sign (#) is the first mode key that can be locked or unlocked. It has a special purpose that is explained in "**Lock or Unlock Data Clearing Access**" on page 20. To see if another key is locked or unlocked, press that key.

3. Press  to change between locked and unlocked. When anyone other than the supervisor tries to enter a locked mode, the display shows **LOCKED**.

NOTE

The following mode keys cannot be locked out:





4. CONTINUE.
-



SET PRINTER OR DEX OPTIONS

1. Follow the steps in "**Gain Access to the Supervisor Mode**" on page 17.

2. Press  , then  until the display shows one of the following:

PRINTER - means that data will be sent directly to a printer,

DEX ONLY - means that data remains in memory after it is downloaded into a portable data collection device,

DEX+CLR - means that resettable data is cleared after it is downloaded into a portable data collection device.

DEX NR - a special DEX option. All sales data will become non-resettable. Consult your DEX supplier before choosing this option.

3. Press  to switch between the three choices.

4. CONTINUE.
-

Shoppertron™ Operator's Guide



LOCK OR UNLOCK DATA CLEARING ACCESS (Supervisor Mode Only)

1. Follow the steps in "Gain Access to the Supervisor Mode" on page 17.

2. Press  , then  until the display shows either:

#. LOCKED or *#. UNLOCKED*.

LOCKED means that non-supervisors cannot clear resettable machine sales

and vend data from the  key.

3. Press  to switch between *#. LOCKED* and *#. UNLOCKED*.

NOTE

The supervisor can clear data regardless of this setting, provided the supervisor code was correctly entered first.

4. CONTINUE.
-



SELECT PRINTER BAUD RATE (Printer Mode Only)

BAUD RATE

The speed of data transfer, expressed in bytes per second. Your printer can receive data at a certain rate, and you must tell the printer what that rate is.

1. Press  . One of the following is displayed:



BAUD 1200, BAUD 2400, BAUD 4800, BAUD 9600

2. Press  until the correct baud rate for your printer is displayed.

3. CONTINUE.
-



SELECT DISPLAY LANGUAGE



1. Press  . The current language is shown in the display. Press  to choose the desired language. Your choices are: *ENGLISH, DEUTSCH, FRANCAIS, ESPANOL, PORTUGUES, SWEDISH, NEDERLANDS, or FINNISH*.

2. CONTINUE.
-

Shoppertron™ Operator's Guide



SELECT COIN MECHANISM AND OPTIONS

1. Press , then press  until the current COIN MECHANISM is shown in the display. Press  to choose the desired coin mechanism.

Your choices are:

MDB MECH, EXEC MECH, DUMB MECH or NO MECH

NOTE

Choose EXEC MECH even if the exec device is a card reader.

2. CONTINUE.
-



SELECT BILL VALIDATOR AND OPTIONS

1. Press , then press  until one of the following is displayed:

NO DBV

- No bills will be accepted or there is no bill validator installed (you can exit the function).

SER.1.2.5.10.20

- The serial bill validator is selected and will accept \$1, \$2, \$5, \$10, and \$20 bills. Use BILL SELECTION METHOD below to change the bills that will be accepted.

PULSE DBV

- The pulse bill validator will accept \$1 bills.

MDB.1.2.5.10.20

- A standard MDB bill validator is selected. It will accept \$1, \$2, \$5, \$10 and \$20 bills. Use BILL SELECTION METHOD below to change the bills that will be accepted.

BILL SELECTION METHOD:

The standard \$1, \$2, \$5, \$10 and \$20 bills are enabled by pressing the **1, 2, 5, 6, or 7** key(s), respectively, to display which bill(s) will be accepted.

An MDB bill validator that accepts non-standard bills or

MDB. <>*

- tokens is connected and operating. Press  to enter list of bills. See "Initial Setup Of Non-Standard Bill Validator" on page 22.

2. Press  to choose the desired option.

3. CONTINUE.
-

Shoppertron™ Operator's Guide



INITIAL SETUP OF NON-STANDARD BILL VALIDATOR

1. Connect the bill validator, and follow the steps in "Select Bill Validator", to select *MDB.12.5.10.20* in the bill validator selection screens. *MDB.<*>* will not



be an option yet. Exit the bill validator setup by pressing . Bill

information is now collected from the validator.

2. Press , then press  until *MDB.<*>* displays.

3. Press . *1.00 ON* will display. The first number (*1*) indicates bill validator channel 1, the *1.00* is the bill denomination, and *ON* indicates that the validator will accept \$1.00 bills.

4. Press  to toggle the bill acceptance *ON* or *OFF*.

5. Press  and  to scroll through the list of other denominations and to set them to *ON* or *OFF*.

6. Press  to move up to the top level screen.

1.00 ON

1. = Bill validator channel 1, each bill has its own channel

1.00 = Bill value

ON = \$1.00 bill will be accepted

1.00 OFF

OFF = \$1.00 bill will not be accepted

TKN

Token bills (same as coupon bills)

NOTE



If a denomination does not display in the scroll list of available denominations, check the binary switch settings for the validator. If the binary switch for a given denomination is set to "off", it will not display in the list of denominations.

7. CONTINUE.

Shoppertron™ Operator's Guide





SELECT CARD READER AND OPTIONS

1. Press , then press  until the current card reader is shown in the display. Press  to choose the desired card reader.
2. Your choices are: *NO CARD*, *DUMB CARD*, or *MOB CARD*.

NOTE

If you selected *NO CARD* you can exit the function.

3. Press  until one of the following is displayed:
REVALUE.ON - Allows credit to be transferred onto the card
- OR -
REVALUE.OFF - Credit cannot be transferred to the card
4. Press  to display the desired choice.
5. CONTINUE.

Shoppertron™ Operator's Guide



SELECT MONETARY OPTIONS

This function lets you:

- Set declining balance,
- Set currency acceptance on low change,
- Set overbuy options,
- Set last bill stacking options

DECLINING BALANCE: Once credit is established, multiple vends may occur until the coin return is pressed.

1. Press , then press  until the display shows *CHANGE XXX*.

X.XX represents the largest denomination coin or bill that will be changed without a purchase. Any non-zero value here will return all escrowed coins. (Each coin denomination for which the coin mech has a tube is called an ESCROWED coin because it can be returned.) When the coin return button is pressed, all coins inserted will be returned provided there is a coin mech tube for each of those coins, EXCEPT in the forced vend mode.

Some examples:

CHANGE 0.00 - Forced vend; NO change returned without a purchase.

CHANGE .25 - Returns change without purchase if all accepted coins are less than .25 denomination or have a payout tube. Acceptance of a dollar coin will not cause a Force Vend if the coin mechanism has a dollar coin payout tube. Otherwise, accepting a dollar coin or accepting and stacking a dollar bill will cause a Force Vend.

CHANGE 1.00 - Bills and non-escrowed coins less than or equal to \$1.00 will be changed without purchase. All escrowed coins are returned.

2. Use the keypad to enter a value for the change number.

3. Press  until one of the following is displayed:

ACC <\$\$ X.XX -Accept any bill of value \$X.XX or less. Hold the last bill which meets or exceeds maximum price in escrow.

- OR -

ACC.STK X.XX -Accept any bill of value \$X.XX or less. Immediately stack the last bill.

Example: If setting is *ACC.STK 1.00* and maximum price is \$1.50. This setting will immediately stack the second \$1.00 bill inserted.

4. Press  to display the desired choice.

Shoppertron™ Operator's Guide

5. The value of "X.XX" has two purposes:
 - a. The value of "X.XX" tells the machine how big a bill or coin to accept even though there is not enough change in the coin mech to cover all possible paybacks.

For example, enter 1.00. Therefore, the machine will take a dollar bill or coin even though there is less than \$1.00's worth of change. Entering 5.00 tells the machine to take a five even though there is less than \$5.00's worth of change, and so forth.

NOTE

This could cause a customer to be short-changed.

Entering **0.00** means that bills or coins will only be accepted if there is enough change to cover them.

- b. The value of "X.XX" tells the machine how much the customer is allowed to overbuy a product. The customer will be short-changed when an overbuy occurs.

Example:

For a value of \$0.25: if there is no change in the machine and the customer inserts a \$1.00 bill. The customer can purchase a product for \$0.75 even though the change cannot be paid back. The customer will be short-changed. Normally a purchase will not be approved unless all change can be paid.

Entering 0.00 means that the vend will only be approved when the correct change can be returned (overbuy disabled).

6. Press  until the display shows: *LOW.MSG X.XX*. The display will show *USE EXACT CHANGE* when the amount of available change in the coin mechanism falls below the value of "X.XX". Enter a value with the number keys. For example, if *LOW.MSG 1.00* is displayed, the *USE EXACT CHANGE* message is displayed when less than a dollar's worth of change is in the coin mechanism.

7. Press  one of the following is displayed:
DECLINE.ON - More than one vend is allowed, with a declining balance.

- OR -

DECLINE.OFF - A declining balance is not allowed.

8. Press  to display the desired choice.
9. CONTINUE.

Shoppertron™ Operator's Guide



SET UP WINNER MODE

WINNER

At preselected intervals, a customer may receive a refund for a selection. You can select the intervals and qualify-

1. Press , then press  until one of the following is displayed:
WINNER OFF Winner function is disabled.

- OR -

WIN XXX Winners are allowed at certain intervals, represented by "XXX".

2. Press  to display the desired choice.

If you selected *WINNER OFF*, you can exit the function.

3. The display shows *WIN XXX*. XXX represents the number of vends which must occur per each winner vend. For example, an interval number of 50 means that a winner can happen any one time during the next 50 vends. Using the number keys, enter an interval number between 10 and 9999.

4. Press . The display shows **. - - - - -*. The asterisk (*) means that all 3 zones are enabled for a winner vend. If you press "1", "2", or "3" on the maintenance keypad, you can limit winners to that respective zone.
5. The dashes in the display represent which levels are allowed winners. Enter numbers on the selection keypad or slide the appropriate door to the right to enable a level, slide the door again to disable it. For example, sliding the doors to levels 1, 3, and 5 will cause the display to look like this: **. 1 - 3 - 5 - - -*, meaning that all zones on levels 1, 3, and 5 can have a winner. The price display for each level will show which (if any) zones are eligible for a winner.

ADVANCED OPTIONS:

Press  to enable all levels.

Press  to deactivate all levels.

Shoppertron™ Operator's Guide

AN EXAMPLE . . .

You want to enable winners in zone 1 on all levels except level 4. Do the following:



- a. At the winner screen, press "1" on the maintenance keypad. 1 is shown in the display instead of *.
- b. Press . The numbers 1 through 9 appear in the display instead of the dashes, and 1 is on all price displays.
- c. Slide the door to level 4 to the right. The number 4 in the display is replaced by a dash, and the price display for level 4 returns to all dashes.

4. CONTINUE.



SET SHOP ZONES

You have the option of locking out 1 or 2 zones. This can be used to reserve products for people who arrive later, such as second or third shift personnel.

1. Press . Press  until the display shows one of the following:
SHOP ALL - Entire drum is available.

- OR -

SHOP 1 - Zone 1 only is available (zones 2 and 3 are locked out).

- OR -

SHOP 1 - 2 - Zones 1 and 2 are available (zone 3 is locked out).

2. Press  until the shopping configuration you want is displayed.
3. CONTINUE.

Shoppertron™ Operator's Guide



SET NUMBER OF COMPARTMENTS

Each zone on a level has two trays, and each tray can have from one to four compartments (see figure below). **HOWEVER, all trays on a level must have the same number of compartments.** Make sure the numbers you enter agree with the actual physical configuration of the compartments. If not, the drum will not stop at the proper location, nor will the tamper check feature work properly.

The following example demonstrates how to set up level 4 to have 3 compartments per tray. First, make sure the physical configuration is established by correct placement of tray dividers. (There will be a total of 18 compartments on level 4.)

1. Press . The display shows *TRAYS (1 - 4)*.
2. Enter the number 3, then slide the delivery door on level 4 to the right. The price display at level 4 shows *3*.
3. CONTINUE.

THE DRUM IS DIVIDED INTO 3 **ZONES** . . .

EACH ZONE ON A LEVEL IS
DIVIDED INTO 2 **TRAYS** . . .

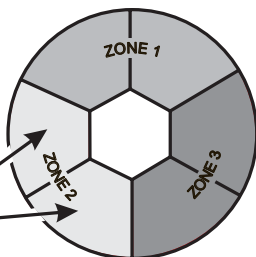

YOU CAN DIVIDE EACH TRAY INTO **COMPARTMENTS**.

NO DIVIDERS = 1 COMPARTMENT, BUT . . .

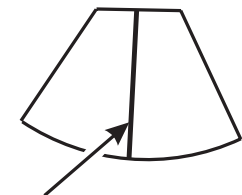

1 DIVIDER
= 2 COMPARTMENTS

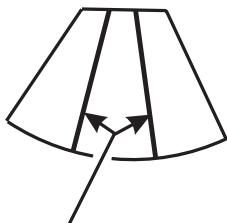

2 DIVIDERS
= 3 COMPARTMENTS

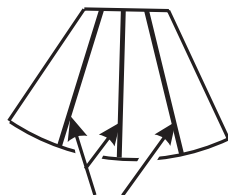



3 DIVIDERS
= 4 COMPARTMENTS

Shoppertron™ Operator's Guide



SET ZONE PREFERENCE



You can select one of three drum movements to occur after a vend:

1. Press  . Press  until the display shows one of the following:
PREFER. 1 - The drum rotates to zone 1 after a vend.
- OR -
PREFER. MAX - The drum rotates to the fullest zone after a vend.
- OR -
NO PREFER - The drum centers itself on the present zone after a vend.
 2. Press  until the zone preference you want is displayed.
 3. CONTINUE.
-



SET VIEW DELAY TIME



After a vend, the drum will remain stationary for a preset amount of time before rotating:

1. Press  . Press  until the display shows *VW.DELAY XX* . "XX" is the number of seconds the drum waits before rotating after a vend.
 2. Enter a new number between 10 and 99, if desired.
 3. CONTINUE.
-



SET DOOR DELAY TIME

After a vend, the door will remain unlocked for a preset amount of time before locking:



1. Press  . Press  until the display shows *DR.DELAY XX* . "XX" is the number of seconds the drum remains unlocked after a vend.
2. Enter a new number between 10 and 99, if desired.
3. CONTINUE.

Shoppertron™ Operator's Guide



SET ALIGN/NO ALIGN OPTIONS

A customer may try to open a vend door when the compartment is one step out of alignment. This function allows you to choose whether the drum automatically corrects itself, or the customer gets a display instructing him to rotate the drum:

1. Press . Press  until the display shows one of the following:

ALIGN ON - The drum moves itself to the correct position.

- OR -

ALIGN OFF - If the customer attempts to open a vend door when the compartment is not aligned, the following message is displayed:



OFF-LINE, PUSH ARROWS

2. Press  until the option you want is displayed.

3. CONTINUE.
-



DISPLAY PRICES (Only in Supervisor Mode)

1. Press , then  until the display shows *PRICE ON* or *PRICE OFF*





2. Press  to turn it ON or OFF. If set to OFF, no prices will show in the price displays.

3. CONTINUE.

Shoppertron™ Operator's Guide





CHANGE TEMPERATURE (Only in Supervisor Mode)

1. Follow the steps in "Gain Access to the Supervisor Mode" on page 17.
 2. Press , then  until the display shows something like +/- +35°F.
 3. Press  to increase temperature,  to decrease temperature.
 4. CONTINUE.
-



SHOW THE TEMPERATURE IN STANDBY MODE (Only in Supervisor Mode)

1. Follow the steps in "Gain Access to the Supervisor Mode" on page 17.
2. Press , then  until something like +/- +35°F displays.
3. Press  an apostrophe is added to the "F". Close the door. The temperature will be included in the ready message once the temperature setpoint is met.
4. CONTINUE.



Shoppertron™ Operator's Guide





SET DEFROST OPTIONS (Supervisor Mode Only)

The Shoppertron has a built-in defrost cycle to assure that ice does not build up on the evaporator coil. Under extremely warm and humid conditions, it may be necessary to adjust the defrost timing (see unscheduled defrosts below).

1. Follow the steps in "**Gain Access to the Supervisor Mode**" on page 17.

2. Press , then  until the display shows *SETDEFROST*.

3. Press . The display will show *X/DAY*. "X" is the number of times per day that the defrost cycle operates. Press  to change the value of X.

4. Press  until the display shows *FOR XXMIN*.

XX represents how many minutes the defrost cycle operates. Press  to change the value of XX.

5. Press  until something like the following displays:

2 > NORM SINCE 2003 07/08 04.28

2 > NORM is a running total of the number of **Unscheduled Defrosts** the compressor has performed since July 8 at 4:28. The time is in 24 hour format.

The controller monitors the compressor operation and may determine that a defrost cycle is necessary in addition to the regularly scheduled defrost. If more than 3 unscheduled defrosts occur per month, check that the door seals properly. If no air leak is apparent, the scheduled defrost cycle can be increased in rate or duration as in steps 2 and 3 above.

If desired, press  to reset the counter to 0 and the counter date and time to the present.



6. CONTINUE.

Shoppertron™ Operator's Guide



TURN TAMPER CHECK ON OR OFF

If a vend door has been moved and there is still a product in that location it is considered to have been tampered with, and should not be sold. Proper operation of this feature assumes that you have configured the machine so that the actual number of compartments per tray agrees with the quantity you entered in "**Set Number of Compartments**" on page 28.

1. Press . Press  until the display shows one of the following:

TAMPER OFF - The tamper check feature is inoperative.

- OR -

TAMPER ON - The tamper check feature is operating.

2. Press  to switch between tamper check on and off.
3. CONTINUE.



CHECK FOR TAMPERING

The following example shows you how to perform a tamper check on a machine which is configured to have 3 compartments per tray on all 9 levels. Our example machine has a total of 24 out of 27 possible items visible in the half-zone behind the delivery doors.

1. Press . Press  until the display shows - *QTY 23*.

This means that the tamper check feature is on and the machine thinks there are 23 items remaining behind the doors (the - 1 shows that the right half of zone 1 is behind the doors). **Remember that with 3 compartments per level, there is a maximum of 27 items that can be present behind the doors.** Therefore, there is one item that is considered sold but is still present.

Next, look at the price displays. Each price display shows whether one or more of the products at that level has been sold. On level 1, the price display shows *1 2 3*. This means that all three compartments on level 1 should be full. You count the products on level 1, and they are all there. On level 2, the price display shows *1 3*. This means that the middle compartment should be empty, but it has a product in it. This product has been tampered with and should be removed.

After the product is removed, the number of full compartments agrees with the number 23 in the display. At this point, you can leave the function,

- OR -

2. Add products to the four empty compartments, then press and hold .



The display shows *CLEARING*, then *FINISHED*. You have now indicated that all the compartments in the machine have products.

3. Repeat steps above until all half-zones in the machine have been checked.
4. CONTINUE.

Shoppertron™ Operator's Guide



VIEW SOFTWARE VERSION

1. Press . Press  until the display shows *VER XXX.XXX*.
"XXX.XXX" represents the current software version number.
 2. CONTINUE.
-



SET THE TIME

1. Press . The display shows *TIME HH.MM*. "HH.MM" is the time of day in 24-hour format.
2. Enter the current time using the number keys.



NOTE

9:00 am is entered with a leading zero, like this: 0900; 9:00 pm is entered as 2100.

3. CONTINUE.
-



SET DAY OF THE WEEK, MONTH, DATE, AND YEAR

1. Press , and press  until the display shows *XX/XX/XX Y*.
XX/XX/XX is the current date. *Y* is the day of the week, with sunday=1, monday=2, etc.
2. Press  to select date format MM/DD/YY or DD-MM-YY.
3. Enter the correct date using the number keys.

NOTE

As you enter a date, the *Y* will disappear and automatically adjust to the correct setting as soon as a valid date is entered. If an incorrect date is



entered, press  to zero the date and then re-enter.

4. CONTINUE.
-

Shoppertron™ Operator's Guide



SET DAYLIGHT SAVINGS OPTION

1. Press , and press  until the display shows something like: *DST N.AMER*
 2. Press to select the appropriate option for your machine. The options are: *DST N.AMER* (North America), *DST UK/EUR.*, *DST AUSLIA*, *DST OFF.*
 3. CONTINUE.
-



SET TIME-OF-DAY INHIBITED VENDING

Vending can be inhibited up to four times a day. This is useful when you want to reserve a zone for a later shift of workers.

1. Press , and press  until the display shows *INHIB - - - -*.
2. Go to "**Time Interval Editing**" on page 36 for an example of how to set up time-of-day inhibited vending.

NOTE



Zones inhibited under "**Set Shop Zones**" on page 27 are always inhibited.

3. CONTINUE.
-



SET TIME-OF-DAY FREE VENDING



Vending can be free up to four times a day.

1. Press , and press  until the display shows *FREEV - - - -*.
 2. Go to "**Time Interval Editing**" on page 36 for an example of how to set up time-of-day inhibited vending.
 3. CONTINUE.
-



SET TIME-OF-DAY DISCOUNT VENDING

Vending can be discounted up to four times a day. For example, this can be used to favor early-arriving employees.

1. Press , and press  until the display shows *DISCT - - - -*.
 2. Go to "**Time Interval Editing**" on page 36 for an example of how to set up time-of-day discount vending.
 3. CONTINUE.
-



TIME INTERVAL EDITING

You can select up to four times of day for each special vending period.

NOTE

If two or more of these time periods overlap, the interval with the highest priority will overrule the other(s). This order of precedence is:

INHIBIT
FREEVEND
DISCOUNT

For example, if a DISCOUNT time period is scheduled for a certain area before the end of an INHIBIT time period, DISCOUNT does not begin until the INHIBIT interval has ended for that area.

The time interval editing procedure is almost the same for the INHIBIT, FREEVEND, and DISCOUNT intervals. There is one difference for the DISCOUNT time interval, so we will use it in our example. Assume you just finished "**Set Time-Of-Day Discount Vending**" on page 35. Step 1 picks up where you left off . . .

1. The display shows *DISCT - - - -*. Press the number of the time interval you

want to edit, or  to edit time interval 1 (we'll use interval 1 for this example).

2. The display shows *IDISCT ON* or *IDISCT OFF*. This display tells you whether

your time interval (represented by 1) is on or off. Press  to change the condition of the time interval.

NOTE

If you turn an interval ON, it must be edited. You can edit a time interval now, then turn it OFF until another time.

3. Press . The display shows *IDSCT X*. "X" represents the discount

percentage for this period. Enter a discount percentage of 25 with the number keys. (Discount percentages of from 0 to 99 are permitted.) The machine will apply a 25% discount to each price, rounding up to the nearest nickel (or whatever is the smallest coin accepted by the coin mechanism).

4. Press . The display shows *I STRT X.XX*. "X.XX" is the currently set



start time. Enter a new start time (24-hour format) for this interval. To enter the time for 3:30 pm, enter 1530.



Shoppertron™ Operator's Guide

5. Press . The display shows *!STOP X.XX*. "X.XX" is the currently set stop time. Enter a new stop time (24-hour format) for this interval. To enter the time for 6:00 pm, enter 1800. You have now established a 25% discount that starts at 3:30 pm and ends at 6:00 pm.

6. Press . The display shows *!@ - - - - -*. The dashes represent the days that this time interval is active. Pressing number keys 1 through 7 switches the days on/off. For example, press "2", "4", and "6". The display now shows *!@ - M - W - F -*. This discount interval is only active on Monday, Wednesday, and Friday.

7. Press . The display shows ** - - - - -*. The asterisk (*) indicates that all zones will be discounted. Press 1, 2, or 3 on the maintenance keypad to limit the discount to one zone. The dashes represent the levels affected by this time interval. Press the appropriate number key(s) on the selection keypad or slide the door(s) of a level to limit the discount to those level(s). For example, pressing 1, 3, and 5 will cause the display to look like this: *! - 3 - 5 - - - -*, meaning that selections on levels 1, 3, and 5 are affected by this interval.

Press  to turn on all levels; press  to turn all levels off.



8. Press . The display shows *!MSG OFF* or *!MSG X*. "OFF" means there is no custom message selected, and "X" represents the custom message number set for this interval. Press the number key of the message (1 through 8) you want displayed. To edit this message, press  and follow the procedure given in "**Edit Custom Messages**" on page 39. Press **0** to turn the message OFF for this time interval.

9. CONTINUE.

Shoppertron™ Operator's Guide





SELECT AN OUT-OF-SERVICE MESSAGE

1. Press , and press  until the display shows *SERVICE M.X.* "X" represents the current message number selected to display when the machine is out-of-service. Two dashes mean that the factory-set message is selected.
2. To select a message, press the corresponding number (1 through 8). To display the factory-set message, press 0.
3. The selected message (except the factory-set message) can be edited. To do this, press  and follow the procedure given in "**Edit Custom Messages**" on page 39.
4. CONTINUE.









SELECT A FREEVEND MESSAGE

1. Press , and press  until the display shows *FREEVEND M.X.* "XX" represents the current message number selected for the message that displays when the machine is in the freevend mode. Two dashes mean that the factory-set message is selected.
2. To select a message, just press the corresponding number (1 through 8). To display the factory-set message, press 0.
3. The selected message (except the factory-set message) can be edited. To do this, press  and follow the procedure given in "**Edit Custom Messages**" on page 39.
4. CONTINUE.

Shoppertron™ Operator's Guide





EDIT CUSTOM MESSAGES

1. Press , and press  until the display shows *EDIT MSG X*.
2. Press the number of the message you want to edit., then press .
The message text is displayed with the first character flashing.
3. To view the message, press . The message scrolls across the display. To stop the scrolling, press .
4. When the character you want to change is flashing, either enter it directly, or use  and  to step through the character set until the desired character is displayed. Use the arrow keys to highlight different characters. See the section on the next page for an explanation of special keys and the character set.

SHORTCUT

Instead of stepping through the whole character set to enter a letter that is not on your keypad, enter one close to the one you want, then

step to it. Example: If you want to enter an **L**, first press ,

then press  six times. Your **L** should now be displayed.

THE END OF MESSAGE CHARACTER

This is the most important character in your message, because it tells the machine when the message is ended. If you don't use this character, your message will be followed by a bunch of zeros. This character can be selected either from the character set or by a direct key entry.



Shoppertron™ Operator's Guide

ENTERING YOUR MESSAGE

Most of the keys on the control panel have a special purpose to help you create and edit your messages:



Inserts an **R** at the flashing character.



Inserts a space at the flashing character.



Inserts an **S** at the flashing character.



Deletes the current character and closes up the space.



Inserts a **T** at the flashing character.



Deletes the current character and leaves the space.



Repeats the letter to the left of the flashing character.



Enters the special "end of message" character, which denotes the end of the message.



"Pages" through the message, ten characters (one screen) at a time.



Steps forward and backward through the message, one character at a time.



Steps forward and backward through the character list, one character at a time. See the character list on the next page.

The Character Set

0	A	J	U	{	
1	B	L	V	}	
2	C	M	W	#	
3	D	N	X	P	
4	E	O	Y	+	
5	F	P	Z	-	>
6	G	Q	(SPACE)	/	?
7	H	R	-	.	@
8	I	S	\$	<	0
9	J	T	□	=	☒

5. CONTINUE.

Shoppertron™ Operator's Guide



VIEW MACHINE TEMPERATURE

1. Press . The display shows *TEMP 38⁰ F*. This example shows that the machine temperature is 38 degrees Fahrenheit.

NOTE

The temperature reading may display one of the following instead of "TEMP", depending on conditions in the machine:

-XX.H - XX is the number of minutes left in the health control grace period (see "**Health Control**" on page 2)

HC.ER - a health control error has occurred.

DEF - the machine is currently in a passive defrost cycle

**X.X* - the temperature has been over the health control limit for x.x minutes.

If "P" replaces "F" or "C" after the temperature, then the temperature is invalid. The last valid temperature is shown. Check diagnostics for the cause, usually a faulty sensor.





A decimal point following "F" or "C" indicates the software has turned the compressor on. If the compressor is not on, check the related wiring.

An apostrophe before the "F" or "C" indicates the software is currently performing a defrost.

2. To change the display units, press . The display now shows *TEMP 3⁰ C*.
3. CONTINUE.





PAYOUT COINS

1. Press . If a dumb mech was selected, the display shows *MD0 = 123*; if an MDB mech was selected the display shows *PAY 123*.
2. Press . A dumb mech pays out one Nickel; an MDB mech pays a coin from tube 1. Press . A dumb mech pays out one Dime; an MDB mech pays a coin from tube 2. Press . A dumb mech pays out one Quarter; an MDB mech pays a coin from tube 3.
3. To continuously pay out coins, hold down the appropriate key.
4. CONTINUE.

Shoppertron™ Operator's Guide





SET PRICES

1. Press  . The display shows ** 2.50 .25. This display shows the maximum and minimum prices set in the machine. In this example, the maximum price is \$2.50 and the minimum is \$0.25.
2. Enter a price using the number keys. For example, the drum is stopped on zone 1 and you entered a price of \$1.25. The display would now show 1* 1.25 . As you can see, one * was replaced by the current zone number. This number will change as you move the drum around to help you see what zone you are in.
3. To assign prices to the various levels, slide the appropriate delivery doors to the right. For example, slide the door to level 4 to the right. The display now shows 4 1.25. As you can see, the other * was replaced by the number of the level you just selected. In addition, the price display for level 4 shows the new price of \$1.25. If you want all zones on that level to have the same price, press  .
4. Repeat steps 2 and 3 for any other levels in the current zone you wish to give different prices.
5. Press the right or left arrow on the selection panel to move the drum to the next zone. Repeat steps 2 and 3 for this and the final zone.
6. CONTINUE.



VIEW NONRESETTABLE SALES AND VEND DATA

1. Press  . The display shows NR\$ XX.XX. "XX.XX" is a dollar and cents figure showing the total of all sales in the machine. This is a running total, and therefore is not resettable.
2. Press  . The display shows NR X. "X" is the total number of sales made by the machine. This is a running total, and therefore is not resettable.
3. CONTINUE.

Shoppertron™ Operator's Guide



VIEW TOTAL PAID SALES



1. Press , then press  until the display shows **\$ XX.XX.



"XX.XX" is a dollar and cents figure showing the total of all **PAID** sales in the machine (as opposed to unpaid sales like winner and free vends). This is the total since the last time it was cleared.

2. CONTINUE.
-



VIEW TOTAL PAID SALES BY ZONE

1. Press , then press  until the display shows **\$ XX.XX.
2. Press 1, 2, or 3. The display shows Z* XX.XX, where "Z" is the zone number



and "XX.XX" is the total for all levels of the zone. Press  or  to switch between all three zones. The price displays show the total paid sales for that level of the current zone.

3. CONTINUE.
-



VIEW TOTAL PAID SALES BY LEVEL

1. Press , then press  until the display shows **\$ XX.XX.

2. Slide the door of the level you are interested in. The display shows *L XX.XX, where "L" is the zone number and "XX.XX" is the total for the entire level. Press  or  to switch between all nine levels. The price displays show the total paid sales for that level of the current zone.

3. CONTINUE.





Shoppertron™ Operator's Guide



VIEW DISCOUNT SALES BY TIME INTERVAL



NOTE

This does not appear if the total of discount sales is zero.

1. Press , then press  until the display shows ****\$ XX.XX**.
 2. Press . The display shows **DISC .00**. This is the total sales for discount interval 1.
 3. Press  to view intervals 2 through 4.
 4. CONTINUE.
-



VIEW TOTAL PAID VENDS



1. Press , then press  until the display shows **** XX**. "XX" is the total number of paid vends for the entire machine.
 2. CONTINUE.
-



VIEW CARD READER PAID SALES

NOTE

This does not appear if the total of card reader sales is zero.

1. Press , then press  until the display shows ****\$ XX.XX**.
2. Press . The display shows **DBT XX.XX**. "XX.XX" is the amount of money collected from card reader sales.
3. CONTINUE.

Shoppertron™ Operator's Guide



VIEW TOTAL UNPAID SALES

NOTE

This does not appear if the total of unpaid sales is zero.

1. Press , then press  until the display shows **.0\$ XX.XX**.

"XX.XX" is the total unpaid sales (free vends, winner vends, 100% discounts, zero price vends) for the entire machine.





2. CONTINUE.
-



VIEW TOTAL UNPAID SALES BY ZONE

NOTE

This does not appear if the total of unpaid sales is zero.





1. Press , then press  until the display shows **.0\$ XX.XX**.
 2. Press **1, 2, or 3**. The display shows **Z0 XX.XX**, where "Z" is the zone number and "XX.XX" is the total for all levels of the zone. Press  or  to switch between all three zones. The price displays show the total unpaid sales for that level of the current zone.
 3. CONTINUE.
-



VIEW TOTAL UNPAID SALES BY LEVEL

NOTE

This does not appear if the total of unpaid sales is zero.

1. Press , then press  until the display shows **.0\$ XX.XX**.
 2. Slide the door of the level you are interested in. The display shows **L0 XX.XX**, where "L" is the zone number and "XX.XX" is the total for the entire level. Press  or  to switch between all nine levels. The price displays show the total unpaid sales for that level of the current zone.
 3. CONTINUE.
-





Shoppertron™ Operator's Guide



VIEW FREE VENDS

NOTE

This does not appear if the total of free vend is zero.





1. Press , then press  until the display shows *.0\$ XX.XX*.
 2. Press , then press  until the display shows *FRV XX.XX*.
"XX.XX" is the total machine-wide freevends.
 3. CONTINUE.
-



VIEW WINNERS

NOTE

This does not appear if the winner total is zero.





1. Press , then press  until the display shows *00\$ XX.XX*.
 2. Press , then press  until the display shows *WIN XX.XX*.
"XX.XX" is the total machine-wide winners, shown even if zero.
 3. CONTINUE.
-



VIEW FREEVEND SALES BY TIME INTERVAL

NOTE

This does not appear if the total of free vend sales is zero.

1. Press , then press  until the display shows *.0\$ XX.XX*.
 2. Press , then press  until the display shows *1FRV .00*. This is the total sales for freevend interval 1, shown even if zero.
 3. Press to view intervals 2 through 4.
 4. CONTINUE.
-

Shoppertron™ Operator's Guide



VIEW TIME DATA

1. Press , then press  until the display shows *TIME DATA*.

2. Press . The following message scrolls across the display:

MAIN.1 237M 0 V30 10.13

This example shows the latest time interval the main (monetary) door was open (1). It was open for 237 minutes, and was opened on January 30 (0 V30)

(0 V30) at 10:13 am (10.13). Press . If applicable, similar displays will appear for intervals 2, 3, and 4. Otherwise, go to the next step.

3. The following message scrolls across the display:

AUX.1 33M 0 V30 10.58

This example shows the latest time interval the auxiliary (cold) door was open (1). It was open for 33 minutes (33M), and was opened on January 30

(0 V30) at 10:58 am (10.58). Press . If applicable, similar displays will appear for intervals 6, 7, and 8. Otherwise, go to the next step.

4. The following message scrolls across the display:

HC.ER 0 V30 14.09 MAX. 69 °F

This example shows that the health control timer turned off on January 30 (0 V30) at 2:09 pm (14.09), and the maximum temperature reached was 69°F.

NOTE

The temperature display units will be in °C if you selected Celsius during the temperature display function.

5. Press . The following message scrolls across the display:

LAST POWER 0 V30 13.51 FOR 00. 0.23

This example shows that the last time the machine lost power was on January 30 (0 V30) at 1:51pm (13.51) for zero days, zero hours, and 23 minutes (00. 0.23).

6. Press . The following message scrolls across the display:

LONGST POWER 0 V30 10.58 FOR 00. 247

This example shows that the longest time the machine was without power was on January 30 (0 V30) at 10:58am (10.58) for zero days, 2 hours and 47 minutes (00. 247).

Shoppertron™ Operator's Guide

7. Press . The following message scrolls across the display:

FULL CLEAR 0 V30 8.58

This example shows that the last time resettable sales was fully cleared was on January 30 (0 V30) at 8:58am (8.58).

8. Press . The following message scrolls across the display:

TIME SET 0 V30 9.15

This example shows that the last time the time or date was set was on January 30 (0 V30) at 9:15 am (9.15).

9. Press . The following message scrolls across the display:

PRICE SET 0 V30 9.42

This example shows that the last time prices were set was on January 30 (0 V30) at 9:42 am (9.42).

10. CONTINUE.
-



VIEW MACHINE ID NUMBER

1. Press  , then press  until the display shows *I.D. XXXXXXXX* .

The X's represent the 8-digit machine ID number.

2. You can edit the machine ID number if the supervisor access code has been previously entered.
3. CONTINUE.
-



CLEAR ALL RESETTABLE DATA

1. Press  . The display shows *NRS\$ XX.XX*. This is a running total, and is not resettable.



2. Press and hold  . Two beeps sound and the display shows *CLEARING* momentarily, and then changes to *FINISHED*. All data is cleared.

3. CONTINUE.
-

Shoppertron™ Operator's Guide



CLEAR PAID SALES DATA ONLY

1. Press , then press  until the display shows ****\$ XX.XX**.
"XX.XX" is a dollar and cents figure showing the total of all **PAID** sales in the machine (as opposed to unpaid sales like winner and free vends). This is the total since the last time it was cleared.
 2. Press and hold . Two beeps sound and the display shows *CLEARING* momentarily, and then changes to *FINISHED*. All paid sales data is cleared; other data is not cleared.
 3. CONTINUE.
-



TEST VEND SELECTIONS AND VERIFY CREDIT ADDED

1. Press . The display shows *TEST .00*. You may now test vend selections. If you insert money into the machine, the zeros in the display will be replaced with the amount of the credit. After the item vends, your money will be returned.





NOTE

You may make one more test vend if you close the door while still in TEST VEND mode.

2. CONTINUE.
-



TEST THE DISPLAY

1. Press , then press  until the display shows *DSPLY TEST*.
 2. Press  to light all display segments; press  to turn them off.
 3. Pressing a number key on the control panel causes all segments to display that character.
 4. CONTINUE.
-

Shoppertron™ Operator's Guide



DOWNLOAD DATA TO A PDCD

1. Connect your portable data collection device (PDCD) per its operating instructions.

2. Press . Data is downloaded into your PDCD.

NOTE



Depending upon the clearing data upon download setting, data may be cleared after the download is complete.

3. CONTINUE.



VIEW DIAGNOSTIC MESSAGES

1. Press . The display shows any of the following diagnostic messages, depending upon any fault(s) present:

NO ERRORS	None of the following errors are detected:
KEYPAD XY	KEY(S) X, Y STUCK.
ROM ERROR	Error in the programming EPROM. MACHINE WILL NOT OPERATE.
RAM ERROR	<p>One or more of the configuration settings may be incorrect. Check the machine settings (time of day, product dividers, pricing, etc).</p> <p>1. If the problem is corrected, the RAM ERROR message can be cleared by pressing  once.</p> <p>NOTE: If the source of the error is not resolved, pressing  will clear the error code, but will not resolve the problem.</p> <p>2. If you cannot find the problem, you can initialize your RAM by performing the following procedure:</p> <p>Press AND HOLD  until two beeps are heard and the display shows FINISHED. Reconfigure the merchandiser.</p> <p>IMPORTANT NOTE: Initializing RAM will erase all data and settings (price, time, monetary options, messages, etc). Be sure you have recorded this information and are ready to reprogram the machine from factory default settings before continuing.</p>

Shoppertron™ Operator's Guide

<i>TEMP .REF</i>	The temperature reference on the main PCB cannot be read.
<i>TEMP .SNS</i>	The temperature sensor cannot be read.
<i>TEMP .RANGE</i>	The temperature sensor is out of range.
<i>CHK PRICE</i>	Price error detected and changed to maximum - check prices.
<i>CHK CONFIG</i>	A PRODUCT CONFIG value was out of bounds and set to nominal - check all PRODUCT CONFIGs.
<i>HC.ER</i>	Presently out of service because of a health control temperature error (MAX. xx°F). Machine will not operate.
<i>NONE READY</i>	No selection is ready to vend. Check that no time-of-day inhibits are active.
<i>NO MECH</i>	Coin mech not detected - machine will not operate if configured for coin mech.
<i>MECH.COMM</i>	Incomplete coin mech communications -- check harness.
<i>MECH.SENSOR</i>	Coin mech reporting a bad tube sensor -- replace mech.
<i>MECH.JAM</i>	<p>One or more coin tubes are jammed. Pay a coin from each tube until the jam is cleared.</p> <p style="text-align: center;">- OR -</p> <p>Coin is jammed in the acceptor section. Check the coin mechanism for a jam in this position. Insert coins and cycle machine power OFF and then ON.</p>
<i>MECH.ROM</i>	Replace the coin mechanism.
<i>MECH.ACCEPT</i>	<p>Coin mechanism acceptor section is unplugged from the main body of the coin mech. Connect the cable and cycle machine power OFF and then ON.</p> <p style="text-align: center;">- OR -</p> <p>The vending machine is telling the coin mech not to accept any coins.</p>
<i>DBV.COMM</i>	Incomplete bill validator communications -- check harness.
<i>DBV.SENSOR</i>	One of the sensors in the bill validator has failed. The unit will disable itself until the error is corrected. Check for bill stuck in the acceptance path. If no bill is present, replace the validator. Cycle machine power OFF and then ON.
<i>DBV.ROM</i>	ROM checksum failure. The unit will disable itself until the error is corrected. Replace the validator.
<i>DBV.JAM</i>	A bill is jammed in the acceptance path. The unit will disable itself until the error is corrected. Remove bill stuck in the acceptance path. Cycle machine power OFF and then ON.
<i>DBV.MOTOR</i>	One of the motors has failed. The unit will disable itself until the error is corrected. Check for bill stuck in the acceptance path. If no bill is present, replace the validator. Cycle machine power OFF and then ON.

Shoppertron™ Operator's Guide

<i>DBV.STACKR</i>	The stacker is open or removed. The unit will disable itself until the error is corrected. Install the stacker correctly. - OR - The stacker is full of bills. Remove bills from the stacker.
<i>DBV.ACCEPT</i>	The vending machine is telling the bill validator not to accept any bills. Check the enabled channels of the bill validator.
<i>CARD.FCOMM</i>	Incomplete card reader communications - check cables. The card reader is not operational.
<i>CARD.COMM</i>	Incomplete card reader communications. Check cables or replace unit.
<i>CARD.ERR</i>	Card reader is indicating it has a problem.
<i>CARD.FERR</i>	Card reader is indicating it has failed. Replace unit.
<i>CARD.ERRXX</i>	Card reader has an error and indicates code XX. The code is defined by the card reader manufacturer. To correct, contact card reader manufacturer. The unit is still operational.
<i>CARD.FERRXX</i>	Card reader has failed and indicates code XX. The code is defined by the card reader manufacturer. To correct, contact card reader manufacturer.
<i>CARD.FJAM</i>	Card reader has failed because card is jammed in the unit. Remove the jammed card.
<i>CARD.SERV</i>	Card reader requires service. The unit is still operational.
<i>SOLENOID</i>	Lock solenoid switch not detected after command to operate solenoid. Machine will not operate.
<i>MOTOR JAM</i>	Motor movement not detected in either direction. Machine will not operate.
<i>NO WHEEL</i>	No valid drum sensor wheel detected after command to turn drum. Machine will not operate.
<i>CANT HOME</i>	No drum home position detected. If no other drum related errors are present, check if home switch operates properly. Machine will not operate.
<i>SW 10-ERR</i>	Door common switch shows a door open even though the door switches indicate that all doors are closed.
<i>TAMPER 123</i>	Attempt to buy a sold compartment in zone 1, 2, or 3.

2. CONTINUE.



SET FREEVEND OPTIONS

1. Press  until one of the following is displayed:

FREE OFF - Normal vending mode. No items are on freevend. A closure on the keyswitch input causes the machine to go out of service.

- OR -

FREE ON - All items are on freevend. The credit display shows
NO MONEY REQUIRED

A closure on the keyswitch causes the machine to go out of service.

- OR -

FREE WJ/KEY - All items are freevended while there is a closure on the keyswitch input. Normal cash sales are supported when the keyswitch input is open.

- OR -

FREE ONCE - A closure on the keyswitch input causes only the next item to be freevended. Coin mechanism errors are ignored. this state is designed for card or token systems where one item is vended per token. Normal cash sales are also supported.

2. Press  until the option you want is displayed.

3. CONTINUE.

Section III. Routine Service and Sanitation

Sanitation is an important phase of merchandiser operation. The lack of proper service and sanitation can cause merchandiser malfunction and loss of sales.

The periods and suggested procedures for service and sanitation are daily, weekly, monthly, and semi-annually. These periods and procedures are given as guides only, and are not to be construed as absolute or invariable. Local conditions must always be taken into consideration. Certain installations require that some or all of the steps under Monthly Service and Sanitation be performed weekly. Each merchandiser must be maintained individually in accordance with its particular requirements. National Vendors, however, stresses "A CLEAN MERCHANDISER IS THE MOST PROFITABLE MERCHANDISER".

Sanitizing means effective bactericidal treatment of clean surfaces of equipment and utensils by a process which has been approved by the health authority as being effective in destroying microorganisms, including pathogens.

Sanitizing processes generally accepted by the health authority are as follows:

1. Immersion for at least one-half minute in clean hot water at a temperature not lower than 170° F (77° C).
2. Immersion for a period of at least one minute in a sanitizing solution containing:
 - a. At least 50 ppm of available chlorine at a temperature of not lower than 75x F (24x C);

- OR -
 - b. At least 12.5 ppm of available iodine in a solution having a pH not higher than 5.0 and a temperature not lower than 75° F (24° C);

- OR -
 - c. Any other chemical-sanitizing agent which has been proven to be effective and non-toxic under usage conditions, and for which a suitable field test is available.

The following warnings and cautions are applicable to the service and sanitation procedures given in this section:

CAUTION

Milk and other foods are perishable products. Follow local health authorities' rules and regulations for storage and handling of these items.

IMPORTANT

All loose food particles or spillage, whether wet or dry, must be removed from the inside and outside of the merchandiser.

CAUTION

Do not get electrical connections or electrical components damp or wet.

NOTICE

Do not use waxes or lubricants that contain silicone on or in the merchandiser. Silicone or silicone vapors can cause electrical failure.

Shoppertron™ Operator's Guide

General

Set the main power switch OFF before cleaning or servicing the merchandiser. Use aerosol spray cleaners or spray waxes only in well-ventilated areas. NEVER use any spray product containing silicone. Silicone sprays can coat electrical contacts, causing a machine malfunction.

WARNING

Before using any liquid cleaner, unplug the merchandiser power cord or shut off power to the wall receptacle to avoid any possibility of electrical shock. Make certain all components are thoroughly dry and properly installed before restoring power.

Refer to the Parts Manual for additional service information and replacement parts. For factory assistance, contact the nearest National Vendors representative.

Contact the local health authorities and obtain their acceptance of the sanitizer you intend to use when cleaning and sanitizing the merchandiser.

When cleaning and sanitizing the merchandiser, use CLEAN, DISPOSABLE PAPER WIPES rather than cloths.

Daily Service

1. Replace burned-out or discolored light bulbs.
2. Replenish coin tubes in the coin mechanism.
3. Empty the bill validator as shown.
4. Test vend the merchandiser. See **"Test Vend Selections and Verify Credit Added"** on page 49.
5. Check the temperature of the cabinet. See **"View Machine Temperature"** on page 41.
6. Follow the daily sanitation procedures, then reload the merchandiser.
7. CONTINUE.

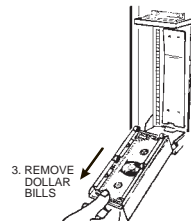
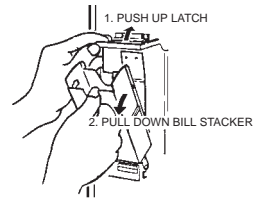

Emptying the Bill Validator

Shoppertron™ Operator's Guide

Daily Sanitation

1. Remove all past-date merchandise from the merchandiser.
2. Check for liquid spillage on the merchandiser modules. If there is spillage, remove the module shelves and dividers affected. Wash and sanitize the shelves and dividers with a clean, damp disposable paper wiper or a clean soft-bristle brush. Rinse with clean hot water and dry thoroughly.
3. Wipe the exterior of the merchandiser with a damp disposable paper wiper and dry thoroughly.
4. Fill in the appropriate columns on the record of cleaning card.

Weekly Service

1. Follow the daily service instructions.
2. Brush the vent screens.
3. Inspect the refrigeration screen. Remove any accumulated dust.
4. Inspect the exhaust filter. Clean and replace it before it becomes clogged.
5. Inspect the coin mechanism, coin validator, and bill validator. Clean if necessary.

Weekly Sanitation

1. Follow the daily sanitation instructions.
2. Inspect the merchandiser for overall cleanliness, especially the corners.
3. Wash and sanitize the merchandiser food compartment with a clean, damp disposable paper wiper. Dry thoroughly.
4. Fill in the appropriate columns on the record of cleaning card.

Monthly Service

1. Follow the weekly service instructions.

WARNING

Be sure the area is well ventilated and no open flames are present before using any aerosol spray can.

WARNING

Use protective glasses or a protective shield if an air hose is used for drying.

2. Clean the coin chute and coin validator. (See "**Cleaning the Coin Validator and Coin Chute**" on page 57.)
3. Clean the bill validator. (See "**Cleaning the Bill Validator**" on page 57.)
4. Remove the vent fan filters. Clean the screens with a dry cloth, then wash with a warm detergent solution. Rinse, dry, and reassemble.

Monthly Sanitation

1. Follow the weekly sanitation procedures.
2. Fill in the appropriate columns on the record of cleaning card.

Shoppertron™ Operator's Guide

Semi-Annual Service

1. Follow the weekly service instructions.
2. Inspect the merchandiser for worn parts and replace where necessary.

NOTICE

Do not use silicone lubricants. Silicone can cause electrical contact failures.

National Vendors recommends using Lubriplate Portable Tool Grease No. 905 (or equivalent), available from:

Industrial Lubricating Company, Inc.
P.O. Box 3871
St. Louis, MO 63122

3. Lubricate the drive motor stop pin. **DO NOT OVER-LUBRICATE!**
4. Lubricate all moving parts that do not come into contact with food.

Semi-Annual Sanitation

1. Follow the monthly sanitation instructions.

Cleaning the Coin Validator and Coin Chute

Inspect the coin validator and coin chute at regular intervals. Clean them on approximately a monthly schedule.

1. Remove the coin validator assembly from the merchandiser.
2. Clean the coin chute with a tube cleaning brush to remove any accumulated dust and foreign matter.
3. Refer to the coin validator instruction booklet and follow the recommended cleaning procedure.

Cleaning the Bill Validator

1. Refer to the bill validator instruction booklet and follow the recommended cleaning procedure.

Section IV. Adjustment, Removal, and Replacement Procedures

Adjusting the Product Dividers

Add or remove product dividers to accommodate various size products. Each level has three zones, each zone has two trays. Each tray can be left alone or divided into 2, 3, or 4 compartments, but **every tray on a given level must have the same number of compartments**. The machine can thus vend 6, 12, 18, or 24 products per level.

THE DRUM IS DIVIDED INTO 3 **ZONES** . . .

EACH ZONE ON A LEVEL IS
DIVIDED INTO 2 **TRAYS** . . .

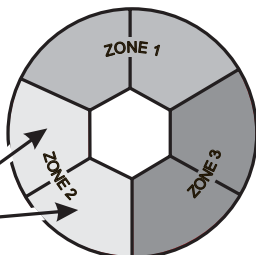

YOU CAN DIVIDE EACH TRAY INTO **COMPARTMENTS**.
NO DIVIDERS = 1 COMPARTMENT, BUT . . .

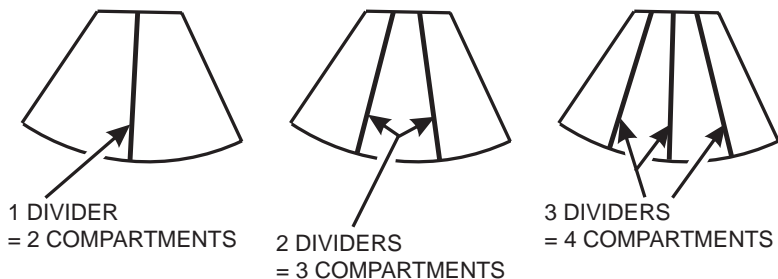

Product Divider Usage

Adjust the dividers as follows:

IMPORTANT

When adjusting product dividers, make sure that all six trays on each level are set the same.

1. Firmly grasp the retainer and slide it out towards you.
2. Remove the divider.
3. Replace the product divider in the desired configuration by in the reverse order of removal.
4. Change the machine program to match the new configuration. See "**Set Number of Compartments**" on page 28.

Shoppertron™ Operator's Guide

5. Adjust the delivery door stops to match the new tray configuration for each level.

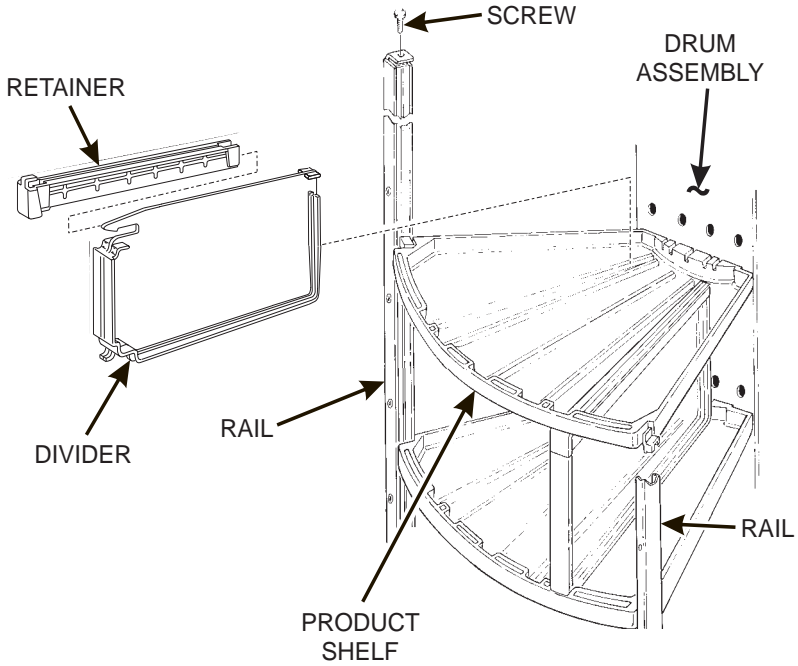

Product Dividers and Shelf Assembly Removal and Replacement

Shoppertron™ Operator's Guide

Adjusting the Delivery Door Stops

Each delivery door has a set of delivery door stops mounted on the bottom of the door guide rail. When the door stop is adjusted correctly, the customer will be able to remove a single product when the door is opened.

1. Adjust each set of door stop(s) as shown to match the number of selections on that level.

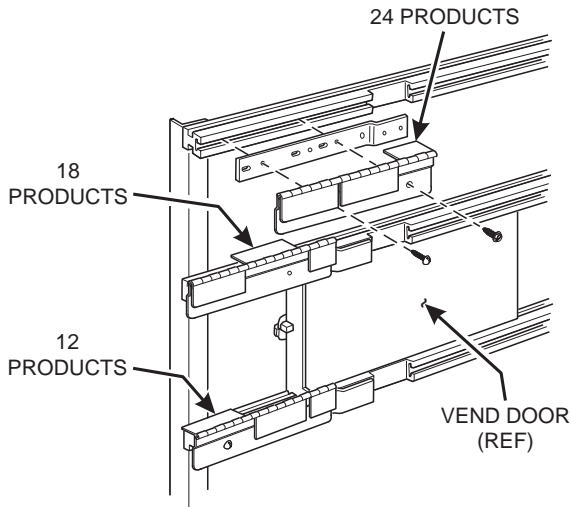

Product Door Stop Adjustment

Shelf Assembly Removal and Replacement

1. Rotate the drum until the shelf to be removed is directly in front.
2. Remove dividers, if applicable. See "**Adjusting the Product Dividers**" on **page 58**.
3. Remove screws and the rails on both sides of the shelf.
4. Slide out the shelf assembly.
5. Replace the shelf by doing steps 1 through 4 in reverse order.

Shoppertron™ Operator's Guide

Drum Assembly Removal and Replacement

WARNING

The Shoppertron door is heavy. The cabinet could tip over if the door is open and weight is removed from the inside of the cabinet. Use the support leg or a solid object to brace the end of the door farthest away from the hinges prior to removing anything from the Shoppertron cabinet.

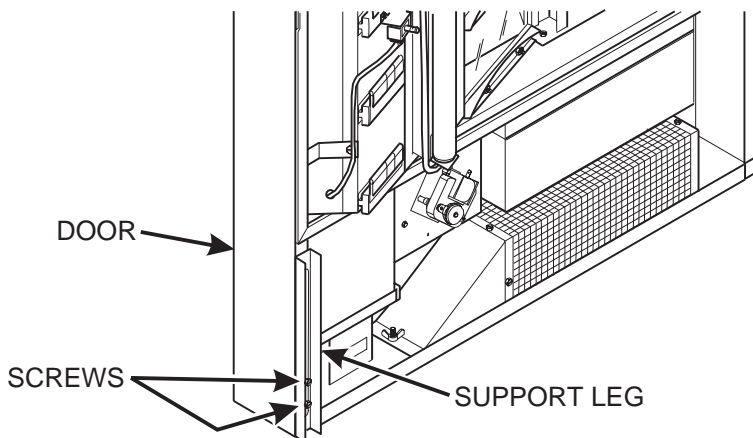

Extending the Support Leg

1. Loosen the two screws holding the support leg to the door.
2. Slide the support leg all the way down toward the floor.
3. Securely tighten the screws.

CAUTION

The EMPTY weight of the food drum is approximately 75 lbs (34.0 kg). Do not attempt to remove or install the food drum without help.

4. Remove the food from the drum assembly.
5. Loosen two screws and remove the top bracket assembly (see figure below).
6. Lift the drum assembly up and out, clearing the drive motor assembly.

Shoppertron™ Operator's Guide

7. To reinstall the drum, reverse steps 1 through 6.

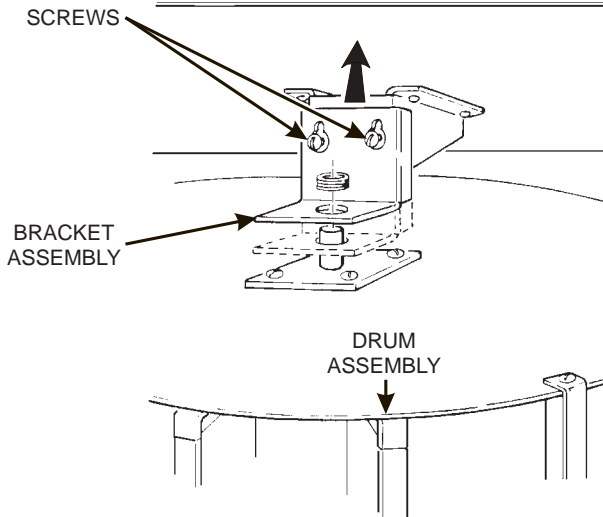

Drum Assembly Removal and Replacement

Shoppertron™ Operator's Guide

Stop Pin Adjustment

Solenoid Position Adjustment

1. Turn the machine power switch OFF.
2. Remove the solenoid cover plate screws (2) and the cover plate (4), as shown.

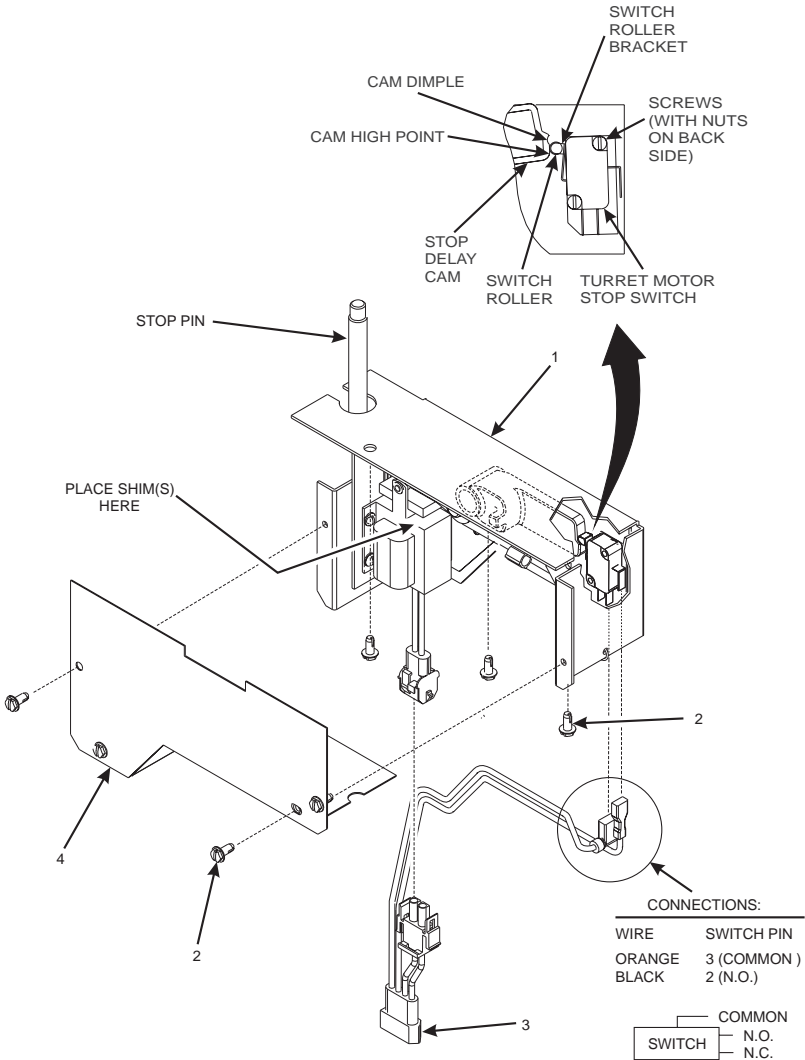

Stop Pin Adjustment

3. Locate the two adjusting screws in the slotted holes to the right of the solenoid. Loosen, but **DO NOT REMOVE** the adjusting screws.

Shoppertron™ Operator's Guide

4. Pull the stop pin down and rotate the drum by hand so the pin rides on the bottom of the drum stop plates.
5. Place a .078 thick shim (or use approximately one to two dimes) under the plunger of the solenoid as shown.
6. Push up on the bottom of the solenoid to raise the assembly to the working position. Tighten the two adjusting screws.
7. Rotate the drum by hand until the stop pin seats into a hole. Remove the shim(s).
8. Turn the machine power switch ON.
9. Test run the drum rotation and locating stop features. If needed, the stop switch can be adjusted for proper engagement.
10. Install the solenoid cover plate to the front of the assembly and secure with two screws.

If necessary, perform the following procedure:

Stop Switch Adjustment

1. Remove electrical power from the machine.
2. Remove the stop pin assembly (1) from your machine.
3. Remove the cover and loosen both stop switch mounting screws.
4. Unhook one end of the spring.
5. Rotate the stop delay cam until the switch roller rides on the cam high point just below the cam dimple.
6. Rotate the switch until the switch roller bracket just bottoms out on the switch housing.
7. Tighten the switch mounting screws.
8. Replace the spring.
9. Replace the stop pin assembly (1) in the machine. Be sure the harness (3) is properly connected.
10. Restore electrical power to the machine and verify that the turret can find its home position.
11. Perform the solenoid position adjustment procedure again, if necessary, to ensure proper stop pin operation.

Shoppertron™ Operator's Guide

Door Side Trim Removal And Replacement

1. Starting at the top of the door, insert a straight slot screwdriver between the door frame and the door trim, and turn it ¼ turn.
2. Using a rubber mallet, tap the door trim off as shown.
3. Move the screwdriver down the door until the door trim is completely removed.
4. Replace the door trim by aligning the trim on the door and tapping it into place with a rubber mallet.

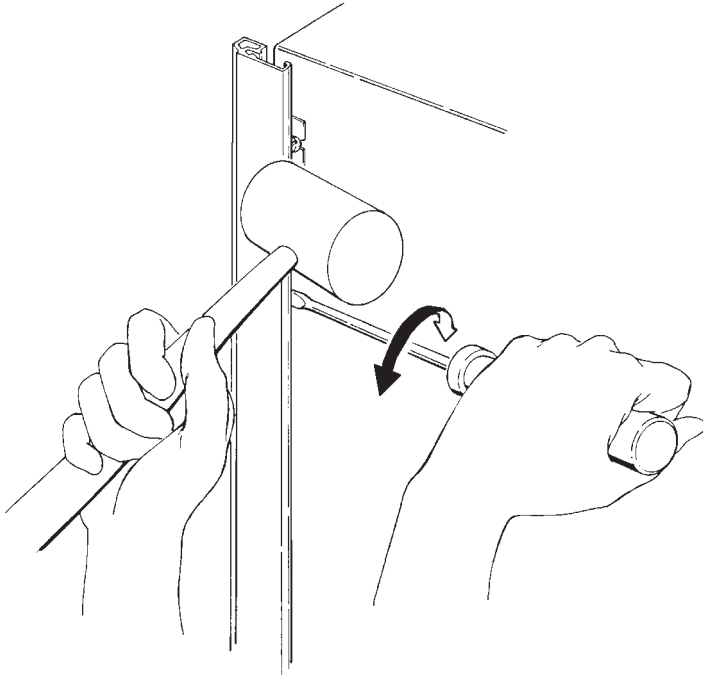

A	I
Align/No Align Option 30	Install
B	Coin Mechanism5
Bill Selection Method 21	M
Bill Validator, Select 21	Machine ID Number, View48
C	Machine Temperature, View41
Card Reader Paid Sales, View 44	Messages, Edit39
Card Reader, Select 23	Monetary Options24
Check for Tampering 33	Money Box Lock, Install7
Coin Mechanism, Select 21	N
Compartments, Set 28	Noise Potential Check3
Custom Messages, Edit 39	Nonresettable Sales Data, View42
D	Non-Standard Bill Validator22
Daily Sanitation 56	O
Data Clearing Access, Lock 20	Out-Of-Service Message, Select38
Data Recall Code, New 18	P
Date, Set 34	Paid Sales Data, Clear49
Day of the Week, Set 34	Payout Coins41
Daylight Savings Option 35	PDCD, Download to50
Defrost Options 32	Polarity Check3
Delivery Door Stops, Adjust 60	Prices, Set42
DEX Options 19	Printer Baud Rate, Select20
Diagnostic Messages, View 50	Printer Options19
Discount Sales by Time Interval 44	Product Dividers, Adjust58
Display Language 20	Programming Flow Charts12
Display Prices 30	R
Display, Test 49	Resettable Data, Clear48
Door Delay Time 29	S
Door Lock, Install 7	Sanitation54
Download Data To a PDCD 50	Set
Drum Assembly, Replace 61	Align/No Align Options30
E	Bill Validator21
End of Message Character 39	Card Reader Options23
F	Coin Mechanism21
Free Vends, View 46	Data Recall Code18
Freevend Message, Select 38	Date34
Freevend Options, Set 53	Day of the Week34
Freevend Sales by Time Interval 46	Daylight Savings35
H	Defrost Options32
Health Control 2	DEX Options19
	Display Language20
	Door Delay Time29

S

Set (cont.)	
FreeVend Message	38
FreeVend Options	53
Monetary Options	24
Non-standard Bill Validator	22
Number of Compartments	28
Out-of-Service Message	38
Prices	42
Printer Baud Rate	20
Printer Options	19
Shop Zones	27
Supervisor Code	17
Time	34
Time-of-Day Discount Vending	35
Time-of-Day FreeVending	35
Time-of-Day Inhibited Vending	35
View Delay Time	29
Winner Mode	26
Zone Preference	29
Shelf Assembly, Replace	60
Shop Zones, Set	27
Software Version	34
Solenoid Position, Adjust	63
Stop Pin, Adjust	63
Stop Switch, Adjust	64
Supervisor Code, Enter new	17
Supervisor Mode, Gain Access	17

T

Tamper Check	33
Temp in Standby Mode, Show	31
Temperature, Change	31
Test the Display	49
Test Vend Selections	49
Time Data, View	47
Time Interval Editing	36
Time, Set	34
Time-Of-Day Discount Vending	35
Time-Of-Day Free Vending	35
Time-Of-Day Inhibited Vending	35
Total Paid Sales by Level, View	43
Total Paid Sales by Zone, View	43
Total Paid Sales, View	43
Total Paid Vends, View	44
Total Unpaid Sales by Level, View ...	45
Total Unpaid Sales by Zone, View ...	45
Total Unpaid Sales, View	45

U

Unscheduled Defrost	32
Utility Requirements	3

V

Verify Credit Added	49
View	
Card Reader Paid Sales	44
Diagnostic Messages	50
Discount Sales Time Interval	44
FreeVend Sales Time Interval	46
FreeVends	46
Machine ID Number	48
Machine Temperature	41
Non-resettable Sales Data	42
Software Version	34
Time Data	47
Total Paid Sales	43
Total Paid Sales by Level	43
Total Paid Sales by Zone	43
Total Paid Vends	44
Total Unpaid Sales	45
Total Unpaid Sales by Level	45
Total Unpaid Sales by Zone	45
Winners	46
View Delay Time	29
Voltage Check	3

W

Winner Mode	26
Winners, View	46

Z

Zone Preference, Set	29
----------------------------	----